

# MERIT BADGE SERIES

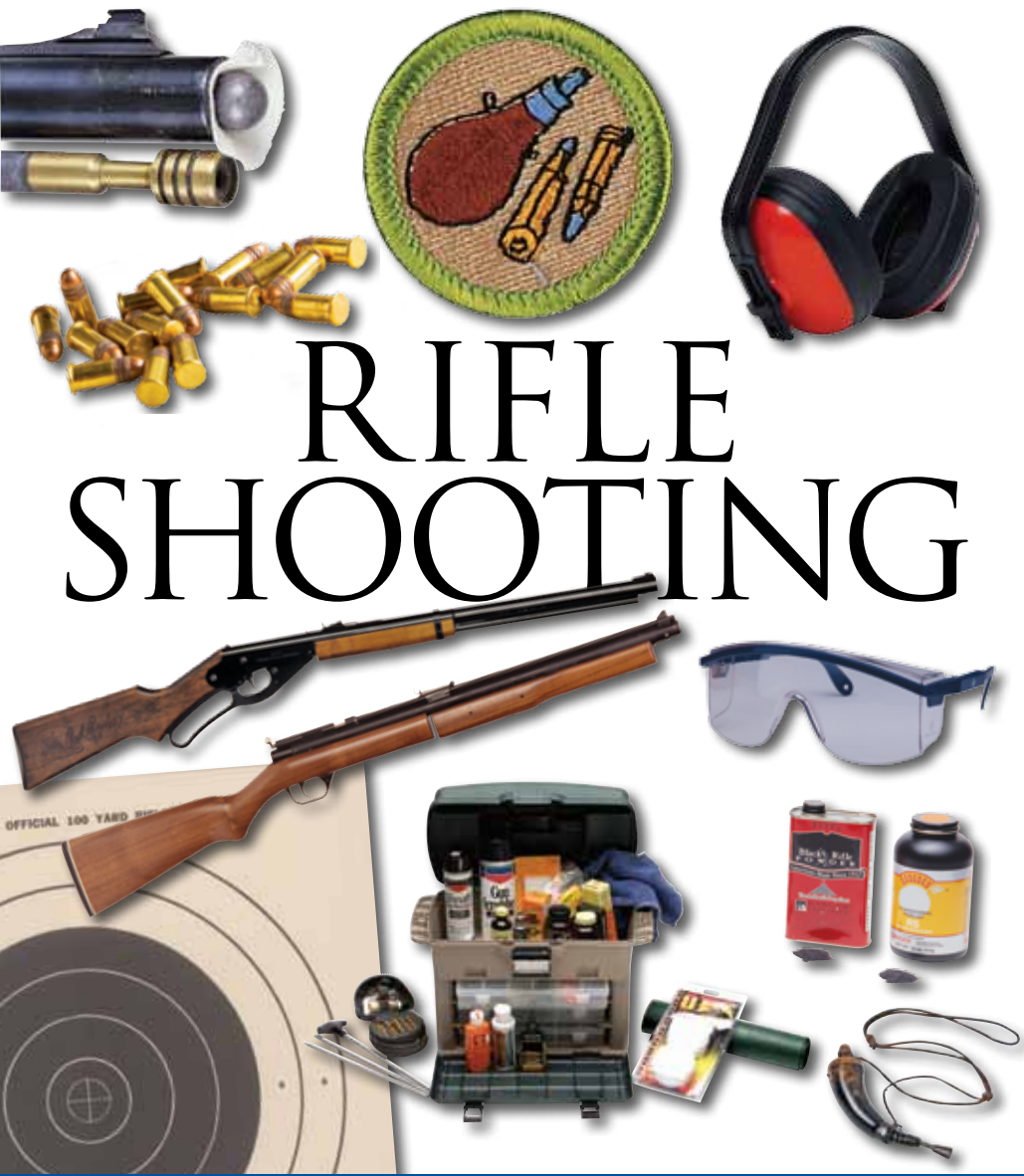

BOY SCOUTS OF AMERICA®



## HOW TO USE THIS PAMPHLET

The secret to successfully earning a merit badge is for you to use both the pamphlet and the suggestions of your counselor.

Your counselor can be as important to you as a coach is to an athlete. Use all of the resources your counselor can make available to you. This may be the best chance you will have to learn about this particular subject. Make it count.

If you or your counselor feels that any information in this pamphlet is incorrect, please let us know. Please state your source of information.

Merit badge pamphlets are reprinted annually and requirements updated regularly. Your suggestions for improvement are welcome.

Send comments along with a brief statement about yourself to Youth Development, S209 • Boy Scouts of America • 1325 West Walnut Hill Lane • P.O. Box 152079 • Irving, TX 75015-2079.

## WHO PAYS FOR THIS PAMPHLET?

This merit badge pamphlet is one in a series of more than 100 covering all kinds of hobby and career subjects. It is made available for you to buy as a service of the national and local councils, Boy Scouts of America. The costs of the development, writing, and editing of the merit badge pamphlets are paid for by the Boy Scouts of America in order to bring you the best book at a reasonable price.



BOY SCOUTS OF AMERICA  
MERIT BADGE SERIES

# RIFLE SHOOTING



BOY SCOUTS OF AMERICA®

# Note to the Counselor

## BSA Standards

Boy Scouts are permitted to fire .22 caliber bolt-action, single-shot rifles; air rifles; shotguns; and muzzleloading long guns under the direction of a currently certified instructor, 21 years of age or older, within the standards outlined in current Scouting literature and bulletins. BSA policy does not permit the use of handguns in the Boy Scouting program.

References: *Guide to Safe Scouting*, No. 34416; *Camp Program and Property Management* (section VI, Shooting Sports), No. 20-920; *Health and Safety Guide*, No. 34415A; *Camp Health and Safety*, No. 19-308.

## Rifles

The following standards are established for rifles used in Boy Scouting:

1. Breech-loading rifles will be single-shot, bolt-action of the .22 caliber rim-fire type only. They may be chambered for the .22 short, .22 long, or .22 long rifle, but not for the .22 WRF, which is a more powerful cartridge. Air rifles are also permitted.
2. Semiautomatic rifles will not be permitted.
3. Repeating rifles with a tubular magazine will not be permitted.
4. Repeating rifles with a removable clip-type magazine will be permitted but must be used as single-loaders.
5. All rifles used in BSA shooting sports must have a trigger pull in excess of 3 pounds and must be tested with a 3-pound weight or scale at least once a week while in use. If the trigger mechanism is activated by the 3-pound pull, the rifle should be immediately removed from service.
6. Shooting safety glasses and hearing protection are required on rifle ranges.
7. All training and shooting activities must be supervised by a currently certified NRA rifle instructor or NRA coach who is 21 years of age or older.

## **Muzzleloaders**

The following standards for muzzleloading long guns are to be used by members of the BSA:

1. Muzzleloading rifles must be recently manufactured, percussion-lock only. The BSA recommends .45 or .50 caliber. Rifles made from kits must be checked by a qualified gunsmith.
2. Recommended loads of black powder or Pyrodex® are not to exceed 1 grain per caliber; 35 grains is frequently sufficient for target shooting at close range.
3. Shooting safety glasses and hearing protection must be worn.
4. All training and shooting activities must be supervised by a currently certified NRA or National Muzzle Loading Rifle Association (NMLRA) muzzleloading rifle instructor who is 21 years of age or older.
5. When loading and firing, each Scout must have one instructor or adult coach under instructor supervision.

# Requirements

1. Do the following:
  - a. Explain why BB and pellet air guns must always be treated with the same respect as firearms.
  - b. Describe how you would react if a friend visiting your home asked to see your or your family's firearm(s).
  - c. Explain the need for, and use and types of, eye and hearing protection.
  - d. Give the main points of the laws for owning and using guns in your community and state.
  - e. Explain how hunting is related to the wise use of renewable wildlife resources.
  - f. Obtain a copy of the hunting laws for your state. Explain the main points of hunting laws in your state and give any special laws on the use of guns and ammunition.
  - g. Identify and explain how you can join or be a part of shooting sports activities.
  - h. Explain to your counselor the proper hygienic guidelines used in shooting.
  - i. Give your counselor a list of sources that you could contact for information on firearms and their uses.

2. Do ONE of the following options:

## Option A—Rifle Shooting (Modern cartridge type)

- a. Identify the three main parts of a rifle, and tell how they function.
- b. Identify and demonstrate the three fundamental rules for safe gun handling.
- c. Identify the two types of cartridges, their parts, and how they function.
- d. Explain to your counselor what a misfire, hangfire, and squib fire are, and explain the procedures to follow in response to each.
- e. Identify and demonstrate the five fundamentals of shooting a rifle safely.
- f. Identify and explain each rule for safe shooting.
- g. Demonstrate the knowledge, skills, and attitude necessary to safely shoot a rifle from the benchrest position or supported prone position while using the five fundamentals of rifle shooting.
- h. Identify the basic safety rules for cleaning a rifle, and identify the materials needed.
- i. Demonstrate how to clean a rifle properly and safely.

- j. Discuss what points you would consider in selecting a rifle.
- k. Using a .22 caliber rimfire rifle and shooting from a benchrest or supported prone position at 50 feet, fire five groups (three shots per group) that can be covered by a quarter. Using these targets, explain how to adjust sights to zero a rifle.
- l. Adjust sights to center the group on the target\* and fire five groups (five shots per group). According to the target used, each shot in the group must meet the following minimum score: (1) A-32 targets—9; (2) A-17 or TQ-1 targets—7; (3) A-36 targets—5.

\*Note: It is not always practical to adjust the sights (i.e., when using a borrowed fixed-sight rifle). For requirement 2l, you may demonstrate your ability to use the shooting fundamentals by shooting five shot groups (five shots per group) in which all shots can be covered by or touch a quarter and then explain how to adjust the sights to zero the rifle used.

#### Option B—Air Rifle Shooting (BB or pellet)

- a. Identify the three main parts of an air rifle, and tell how they function.
- b. Identify and demonstrate the three fundamental rules for safe gun handling.
- c. Identify the two most common types of air rifle ammunition.
- d. Identify and demonstrate the five fundamentals of shooting a rifle safely.
- e. Identify and explain each rule for shooting an air rifle safely.
- f. Demonstrate the knowledge, skills, and attitude necessary to safely shoot a target from the benchrest position or supported prone position while using the five fundamentals of rifle shooting.
- g. Identify the basic safety rules for cleaning an air rifle, and identify the materials needed.
- h. Demonstrate how to clean an air rifle safely.
- i. Discuss what points you would consider in selecting an air rifle.
- j. Using a BB gun or pellet air rifle and shooting from a benchrest or supported prone position at 15 feet for BB guns or 33 feet for air rifles, fire five groups (three shots per group) that can be covered by a quarter.
- k. Adjust sights to center the group on the target and fire five groups (five shots per group). According to the target used, each shot in the group must meet the following minimum score: (1) BB rifle at 15 feet or 5 meters using TQ-5 targets—8; (2) pellet air rifle at 25 feet using TQ-5 targets—8, at 33 feet or 10 meters using AR-1 targets—6.

### Option C—Muzzleloading Rifle Shooting

- a. Give a brief history of the development of muzzleloading rifles.
- b. Identify principal parts of percussion and flintlock rifles and discuss how they function.
- c. Demonstrate and discuss the safe handling of muzzleloading rifles.
- d. Identify the various grades of black powder and their proper use.
- e. Discuss proper safety procedures pertaining to black powder use and storage.
- f. Discuss proper components of a load.
- g. Identify proper procedures and accessories used for loading a muzzleloading rifle.
- h. Demonstrate the knowledge, skills, and attitude necessary to safely shoot a muzzleloading rifle on a range, including range procedures.
- i. Shoot a target with a muzzleloading rifle using the five fundamentals of firing a shot.
- j. Identify the materials needed to clean a muzzleloading rifle safely. Using these materials, demonstrate how to clean a muzzleloading rifle safely.
- k. Identify the causes of a muzzleloading rifle's failure to fire and explain or demonstrate proper correction procedures.
- l. Discuss what points you would consider in selecting a muzzleloading rifle.
- m. Using a muzzleloading rifle of .45 or .50 caliber and shooting from a bench-rest or supported prone position, fire three groups (three shots per group) at 50 feet that can be covered by the base of a standard-size soft drink can.
- n. Center the group on the target and fire three groups (five shots per group). According to the target used, each shot in the group must meet the following minimum score: (1) at 25 yards using NRA A-23 or NMLRA 50-yard targets—7; (2) at 50 yards using NRA A-25 or NMLRA 100-yard targets—7.



## Contents

Rifle Parts . . . . .	8
Gun Safety . . . . .	16
Choosing a Rifle . . . . .	21
Air Rifles . . . . .	26
Care of Your Rifle . . . . .	29
Ammunition . . . . .	33
Rifle Shooting Fundamentals . . . . .	36
Shooting Positions . . . . .	42
Firing Your First Shots . . . . .	51
Scoring . . . . .	56
Olympic Games and Shooting . . . . .	57
Muzzleloading Rifles . . . . .	60
Conservation and Hunting . . . . .	82
What's Next? . . . . .	86
Glossary . . . . .	88
Resources . . . . .	95

# Rifle Parts

A rifle is a precision instrument, designed for precise work. It is designed to shoot a *projectile* (a bullet, BB, pellet, ball, etc.) to hit where the barrel is pointed.

It's helpful to learn the parts of a rifle. Then, when you read about how to handle a gun, you'll be able to quickly understand the information.

(Note: For easy reference, terms in *italics* are further defined in the glossary.)

A rifle is divided into three major parts or groups:

- The *stock*—the handle by which the rifle is held and which holds the other groups together
- The *barrel*—the metal tube through which the projectile passes when the rifle is fired
- The *action*—the group of moving parts that load, fire, and unload the rifle

Let's look at each of these main groups.



## Major rifle parts

## The Stock

Most stocks are made of wood, but today more and more stocks are made of fiberglass and other synthetic materials. The stock has special design features to give the shooter comfort, ease of handling, and maximum shooting accuracy. The stock is divided into four basic parts: butt, comb, grip, and fore-end.

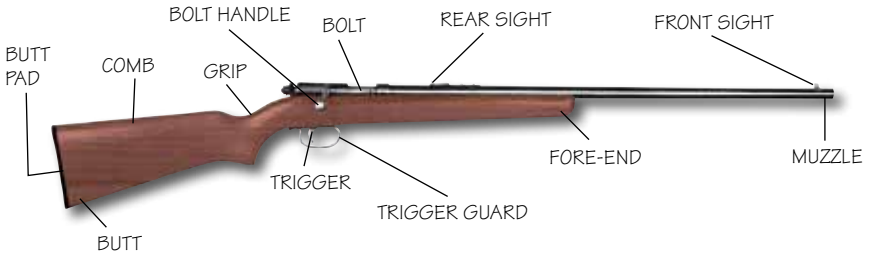

### Parts of a rifle

The *butt* is the rear portion of the stock. It usually is contoured to fit comfortably against the shoulder. The *comb* is the top portion of the stock upon or against which the shooter rests his cheek. The *grip*, or “small of the stock,” is the area where the firing hand grasps the stock. The *fore-end* is the part of the stock that extends under the barrel. This is the area where the nonshooting hand supports the rifle.

## The Barrel

The hollow inside the barrel—the hole through which the projectile passes—is called the *bore*. The bore is measured in fractions of an inch or in millimeters. This measurement is called the *caliber* of the rifle. The larger the diameter of the bore, the larger the caliber and, therefore, the larger the size of projectile it will take.

The opening through which the projectile leaves the barrel is called the *muzzle*. The rear of the barrel is called the *breech*. The *chamber* is located at the breech end of the barrel. That is the portion of the barrel (bore) into which one *round* of ammunition (or *cartridge*) is placed for firing. Chambers are shaped to exactly match the ammunition. As long as you are using the proper size ammunition, the fit should be nearly perfect.

For the remaining length of the barrel, the bore is lined with spiral grooves, somewhat like the grooves on the inside of a machine nut. The flat, raised ridges of metal standing between the grooves are called *lands*. When a projectile passes through the barrel, the lands cut into the bullet to make it spin. This spinning action makes the projectile more stable and accurate in flight toward the target. The projectile in flight is similar to a well-thrown football. The grooves and lands inside the barrel are known as *rifling*, which is where the rifle got its name.

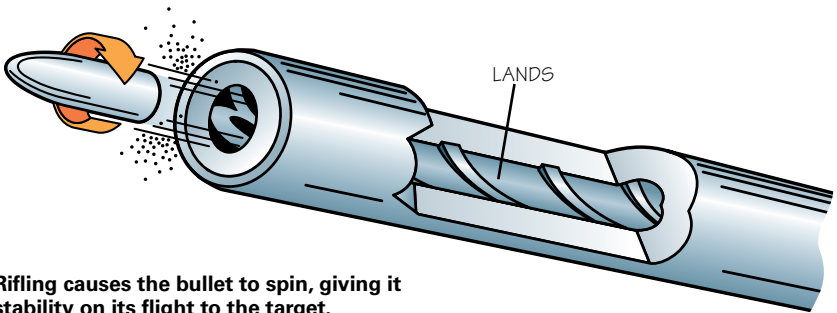

**Rifling causes the bullet to spin, giving it stability on its flight to the target.**

## The Action

The *action*, as explained above, is the group of moving parts that allow the shooter to load, fire, and unload the rifle.

- Loading involves opening the action, placing a cartridge in the chamber, and then closing the action with the cartridge in place. In most rifles, opening and closing the action cocks the *firing pin*, making the rifle ready to be fired. Some rifles must be cocked separately.
- Firing takes place when the trigger is pulled to the rear. This action allows the firing pin to strike the cartridge and fire the gun.
- When the action is opened after firing, the used cartridge is ejected so that a new one can be loaded.

## Other Features

Many rifles have other features such as the magazine, clip, trigger guard, and safety.

The *magazine* is a container with a spring into which several cartridges can be placed. The two most common types of magazines are a nondetachable box type located inside the bottom portion of the action and a tube type located under the barrel or in the stock.

Detachable magazines can be loaded and then slipped into place in the gun. The magazine uses a spring to push the unfired cartridges into the path of the *bolt* for loading.

A rifle chamber can contain only one cartridge at a time. The magazine makes it possible to load a new cartridge into the chamber without having to load it by hand. When an action is opened and closed, a new cartridge is pushed from the magazine into the chamber.

A *clip* is a device to hold cartridges for charging the magazines of some rifles.

The *trigger guard* is a protective shield around the trigger that keeps the trigger from being pulled accidentally.

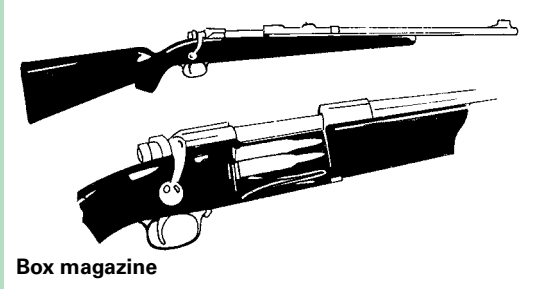

Box magazine

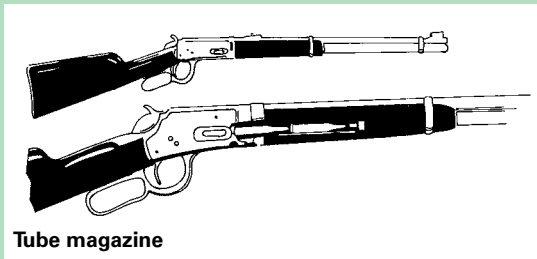

Tube magazine

The *safety* is a mechanical device designed to prevent a gun from being fired accidentally. When the safety is in the “on” position, it should block the operation of the trigger, thus preventing the rifle from firing. Always remember that the safety is only a mechanical device. Never depend on it as a substitute for following the safety rules. **You are the ultimate safety!**

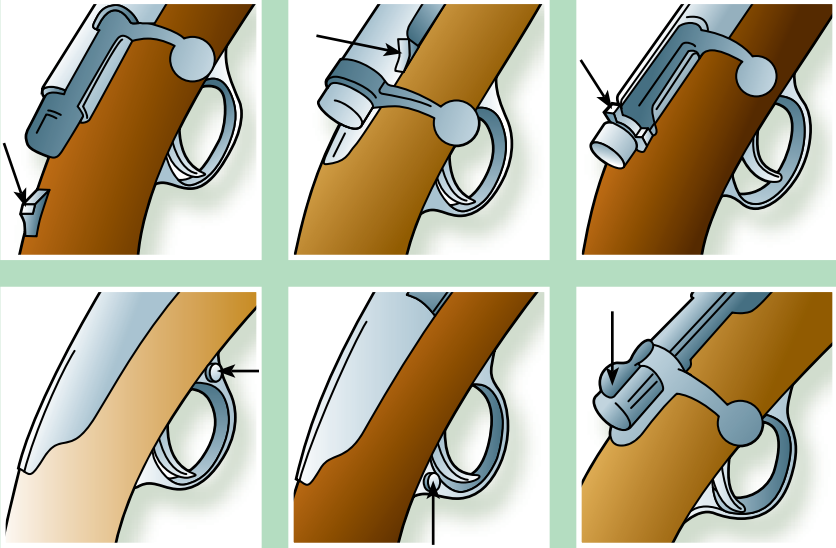

**Safeties are found in a variety of locations on the gun, depending on the rifle's design and manufacture.**

## Types of Actions

There are several popular types of cartridge-rifle actions. To give a general idea of how these actions operate, the following describes the loading and unloading procedures for some of the more common rifle designs: *bolt*, *pump*, *lever*, *semiautomatic*, *hinge*, and *falling-block* actions. Be aware, however, that there are many operational variations for these as well as other types of action designs. You must thoroughly study and understand the rifle's operation manual before using the rifle.

**Bolt.** The bolt-action rifle operates on a lift, pull, and push sequence similar to a door bolt. The bolt action is probably the most common type. Many feel that it is the strongest and most accurate of the action types. Scouts may use this type of rifle to earn this merit badge.

**Pump.** On pump-action (also called *slide-action*) rifles the fore-end of the stock is pumped back and forth to open and close the action. Using a pump-action rifle, experienced marksmen can quickly load, fire, and eject the spent cartridge while keeping the rifle pointed toward the target.

**Lever.** The action on a lever-action rifle is opened by pulling the cocking lever downward and forward away from the stock. It is closed by simply returning the lever to its original position. Lever-action rifles, like pump-action rifles, also allow rapid reloading.

**Semiautomatic.** These actions are sometimes called *repeaters* or *auto-loaders*. Each time a semiautomatic rifle is fired, burning powder in the cartridge produces gas that provides the energy to open the action and eject the cartridge case. A spring then closes the action, reloading a new cartridge at the same time. This happens *once* each time the trigger is pulled.

**Hinge.** The hinge action opens similarly to the movement of a door hinge. When the release lever is pushed to one side, the barrel swings downward. Hinge-action rifles may have one, two, or three barrels. Double rifles are built as either an “over and under” or a “side by side,” depending on the placement of the barrels. Three-barreled guns usually have a combination of shotgun and rifle barrels and are often called *drillings*.

**Falling Block.** The falling-block action uses a block instead of a bolt to hold the cartridge in place at the breech end of the barrel. The action is opened by lowering the trigger guard or the small lever under it that causes the *breechblock* to fall down and away from the barrel. Raising the lever closes the action and covers the breech end of the barrel. Falling-block rifles are single-shot rifles.

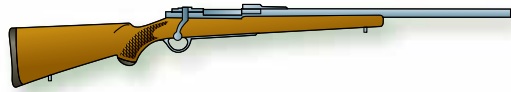

BOLT ACTION

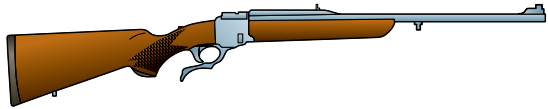

LEVER ACTION

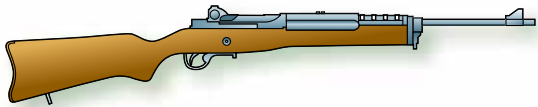

SEMIAUTOMATIC

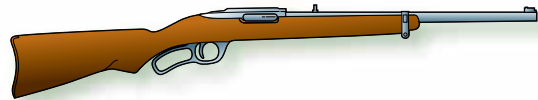

FALLING BLOCK

### Common types of actions

## Sights

**Sights** help you aim the rifle. There are many different types of sights, but generally they fall into three categories: optical, open, and aperture.

**Optical sights** are telescopes mounted atop the barrel or *receiver* (the frame for the action parts of a gun). They are good sights for new shooters because they are simple to use. Optical sights have a crosshair or dot that acts as an aiming point. It's important that the sights be of the right design and size for the rifle. Optical sights should be mounted far enough forward to assure that the rifle's recoil won't cause the sight to strike the shooter's eye or eyewear.

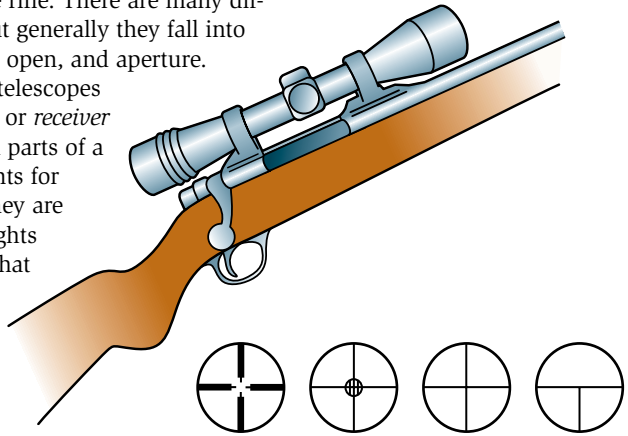

**Pictured are some of the common *reticles* (aiming devices) found in optical sights. Left to right: duplex, dot, crosshair, and post. Choosing which to use is largely a matter of personal preference.**

**Open sights** have a notch or "V" located near the rear or breech end of the rifle, and a front sight (a post or bead) located near the muzzle. To aim, the shooter aligns the front and rear sights with the target.

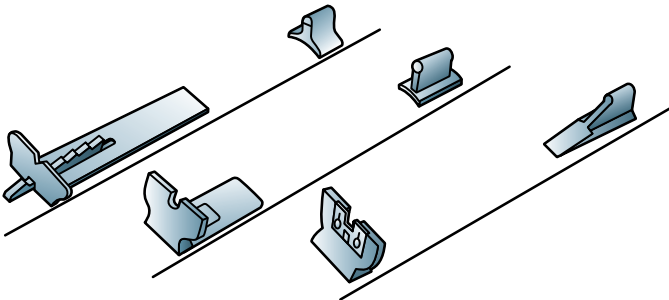

**Open sights are available in various adjustable and fixed designs.**



**Aperture sights** are often called *peep sights* because they have a small hole in the rear sight that the shooter looks through (or peeps through) when aiming. The front sight is aligned in the center of the rear sight opening, making alignment of the sights much easier and more precise than with open sights. However, peep sights aren't as fast and easy to use as open sights when shots must be fired quickly.

Aperture rear sights, scopes, and some open sights can be precisely adjusted without special tools. This adjustment is absolutely necessary for getting shots to hit the center of the target. Usually both *elevation* (up and down) and *windage* (left and right) adjustments can be made. The cardinal rule for adjusting sights is to move the rear sight in the same direction desired for the shots on the target or to move the rear sight to the center of the target. (For more on adjusting the sights, see "Firing Your First Shots.")

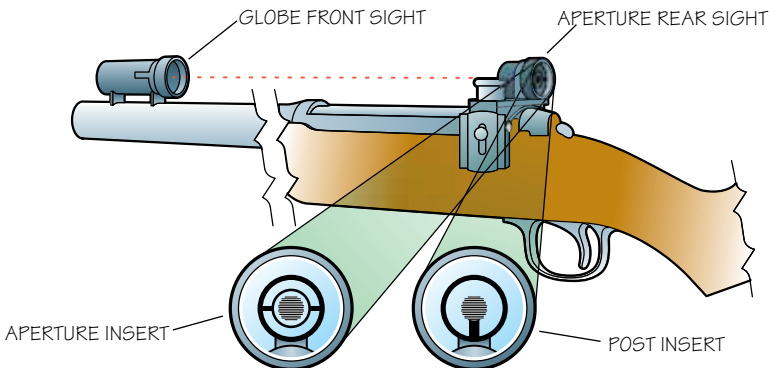

GLOBE FRONT SIGHT AND BULL'S-EYE AS SEEN THROUGH THE APERTURE REAR SIGHT

**Globe front sights with aperture or post inserts are popular with target shooters because they allow precise aiming.**

# Gun Safety

In marksmanship, nothing is more important than safety. Participants in shooting sports assume a vital responsibility that affects the lives of others. It is critically important to learn and practice *all* of the rifle safety rules.

## The Scout Marksman's Code

A Scout:

Always follows the rules for firearms safety.

Accepts the responsibility that goes with the use and possession of firearms.

Follows the laws that govern the use and possession of firearms in his community.

Practices wildlife conservation.

Follows the spirit and the letter of the game laws.

Is especially careful to be a true sportsman when using firearms.

When handled correctly and used properly, a rifle is not dangerous. A rifle, like any other precision machine, instrument, or piece of sports equipment, is manufactured to perform a specific task and can do so at no risk to the user or others. If a rifle is handled incorrectly or recklessly, without regard for the safety rules, then accidents can happen.

Rifle safety is a simple but ongoing process. You must first acquire knowledge of how to handle rifles safely, then develop and maintain proper safe-handling skills through practice. The most important element to being safe is attitude. Safety knowledge and skills are of little value without a determination to use them *all* of the time. Being safe means consciously keeping the gun under control. Always be alert to, and conscious of, the rifle's capabilities, and be aware of what might happen if it is used improperly.

Basic gun safety rules fall into two major categories: safe gun handling and safe use and storage.

## Fundamental Rules for Safe Gun Handling

Three basic rules apply to handling a rifle—under any circumstances.

**1. ALWAYS keep the gun pointed in a safe direction.**

This is the primary rule of gun safety. “Safe direction” means that the gun is pointed so that even if it were to go off, it would not cause injury or damage. The key to this rule is to control where the muzzle or front end of the barrel is pointed at all times. Common sense dictates the safest direction, depending on circumstances.



**ALWAYS keep the gun pointed in a safe direction.**

**2. ALWAYS keep your finger off the trigger until you are ready to shoot.**

When holding a gun, rest your finger along the side of the gun. Until you are actually ready to fire, do not touch the trigger.



**ALWAYS keep your finger off the trigger until you are ready to shoot.**

- 3. ALWAYS keep the gun unloaded until ready to use.** When picking up a gun, carefully point it in a safe direction. Engage the safety if possible. Then, while keeping your finger off the trigger, open the action and look inside the chamber(s), which should be clear of ammunition. (If the gun has a magazine, remove it before opening the action and make sure it is empty.) If you do not know how to open the action or inspect the chamber(s), leave the gun alone and get help from someone who does.



**When picking up a gun, carefully point it in a safe direction, engage the safety, open the action, and check to be sure the chamber is clear of ammunition.**

## Rules for Using or Storing a Gun

When actually engaged in shooting—whether in hunting, recreational practice, or competition—always follow these rules.

- **Know your target and what is beyond.** Be absolutely sure to identify the target beyond any doubt. Equally important, be aware of the area beyond the target. This means observing the prospective area of fire before shooting. Never fire in a direction in which there are people or where any other potential for mishap might exist. Think first. Shoot second.
- **Know how to use a gun safely.** Before handling a gun, learn how it operates. Know its basic parts and how to safely open and close the action, and remove any ammunition from the gun or magazine. Remember, a gun's mechanical safety device is never foolproof. Nothing can replace safe gun handling.
- **Be sure the gun is safe to operate.** Just like other tools, guns need regular maintenance to remain in good working order. Regular cleaning and proper storage are part of the gun's general upkeep. If there is any question about a gun's ability to function, a gunsmith should look at it.
- **Use only the correct ammunition for the gun.** Only the BBs, pellets, cartridges, or ammunition designed for a particular gun can be fired safely in that gun. Most guns have the ammunition type stamped on the barrel. Ammunition can be identified by information printed on the box and sometimes stamped on the cartridge. Do not shoot the gun without loading the proper ammunition.
- **Wear hearing and eye protection.** Shots fired from guns are loud, and the noise can damage the hearing of shooters and by-standers. Firing a gun also emits debris and hot gas that can cause eye injury. For these reasons, shooters should wear shooting glasses and hearing protection.
- **Never use alcohol or drugs before or when shooting.** Alcohol, or any other substance likely to impair normal mental or physical functions (including prescription and nonprescription medicines), must not be used before or while handling or shooting guns.
- **Store guns so they are not accessible to unauthorized persons.** Deciding where and how to store guns and ammunition depends on several factors, such as security and accessibility. Safe and secure storage requires that untrained individuals (especially children) be denied access to guns and ammunition.



**Wear eye and hearing protection when you are shooting.**

## Shooting Ranges

The supervised shooting range is one of the safest places to enjoy shooting. The operators of most ranges use standard range commands to control shooting and to promote uniform safety practices. Range commands and rules let everyone shoot safely. In every case, the undisputed boss is the range safety officer, who gives the commands and monitors all shooters to be sure they comply with the safety rules. It is your responsibility as a shooter to obey and respect the range officer.

The range has:

- A range safety officer
- A ready area
- A firing line
- Firing points
- Target holders
- A backstop

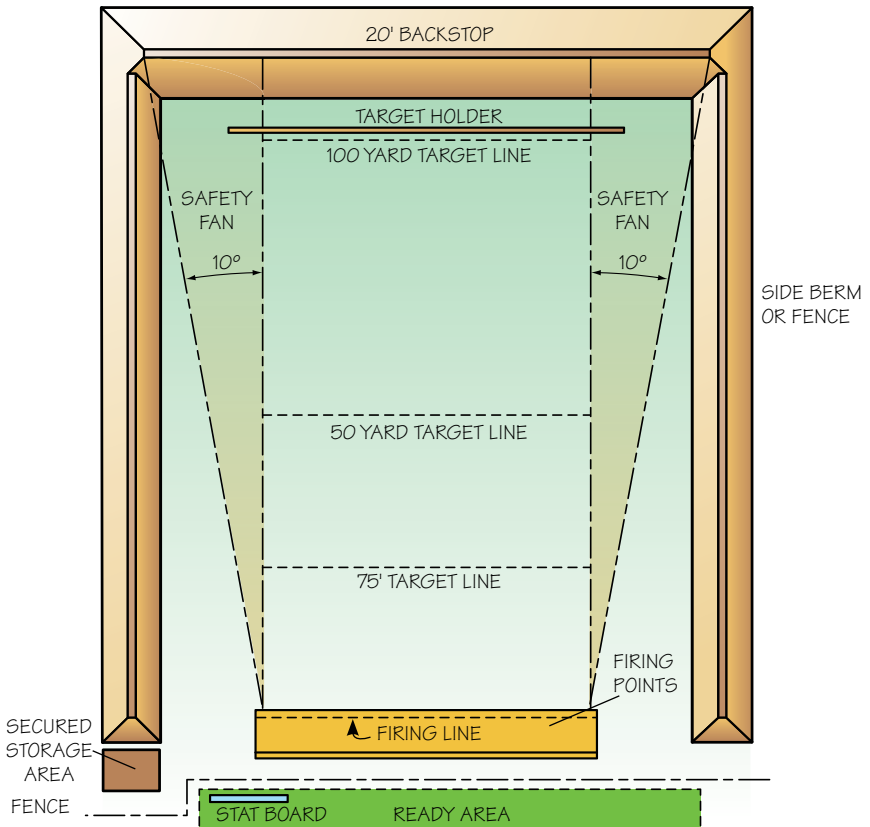

**Typical shooting range**

Shooters use the preparation area behind the firing line to get their equipment ready and wait for their turn to shoot. Shooters take their positions on the point just behind the firing line. Most ranges provide a target holder at the proper distance from the firing line. The backstop behind the target holder catches the bullet just after it goes through the target so there will be no danger to people or property beyond the range.

Here are a few of the range commands you may hear a range safety officer use.

- **“First relay—on the firing line.”** This means that the shooters assigned to that relay may now take their places on the firing line.
- **“Is the line ready?”** When everyone appears ready, the range safety officer will inquire with this command (question). Anyone not ready should call out, “Not ready,” and the range officer will state, “The line is not ready.” When the difficulty is corrected, the range officer will repeat, “Is the line ready?”
- **“Load.”** This is normally the next command. It means that you can now load your rifle but not fire it.
- **“Ready on the firing line.”** This is the last preparatory command.
- **“Commence firing.”** This command means that you may begin shooting and that the time for the relay has begun.
- **“Cease fire.”** When the time for the relay ends or everyone has finished shooting, or if there is a problem that requires shooting to stop, the range safety officer commands, “Cease fire.” Everyone stops shooting immediately. Additional commands to unload, open the action, and bench or ground the firearm may follow.

Depending on the shooting facility, the number of people shooting, the type of shooting equipment being used, or other variables, additional commands may be used. Generally these additional commands direct the flow of shooters to and from the firing line, provide necessary instructions, or inform shooters of the time remaining.

Regardless of the shooting conditions, you have an important responsibility. If you see an unsafe situation in which someone could get hurt, then it is your responsibility to call “Cease fire.” Don’t wait for the range safety officer to notice. Remember, anyone can call a “cease fire” in an emergency.

# Choosing a Rifle

Buying a rifle can be a memorable experience. Picking the right one is important. Before making a selection, review local and state laws that apply to the purchase, ownership, use, possession, and carrying of firearms. These laws vary widely according to community and state. Then begin thinking about what type of firearm best fits your needs. The following guidelines will help.

## Purpose

The first consideration in buying a rifle is: Why do you want it? There are many types of rifles, and each has a specific purpose. One would not want to buy a hunting rifle to shoot competitively, for example. Knowing what you want to use the rifle for can save money and frustration. Patient searching will pay off and help you find the right rifle.

The local library or bookstore is a good place to begin your study. Visiting a local sporting goods or gun specialty store is also a must. Find an interested salesperson who will explain the features of the models you're studying. Be specific about your interests, plans for use, and budget. In all you do, take your time. Be careful not to buy on impulse or because of a sales pitch.

## Action

A good action is one that can be kept open during handling and that permits an easy visual check of the chamber (and of the magazine, if the rifle has one). After trying out the various action types, you probably will develop a preference for one.

## Trigger

For safety reasons, rifles used in BSA shooting programs must have a 3-pound or greater trigger pull. Rifles used for other purposes, such as the smallbore rifles shot in competition, have a much lighter trigger pull.

## Weight

The weight of a rifle is an important consideration when selecting a gun. The proper weight depends on the rifle's intended use and your current physical development. If you are still growing, a lighter rifle will be easier to handle. A larger Scout or an adult will probably want a heavier rifle. A Scout shooting a .22 who is just getting started will want a rifle that weighs about 5 to 7 pounds. A serious target shooter or an adult selecting a high-powered rifle may want something heavier, maybe as much as 10 to 17 pounds. In any case, the rifle needs to be heavy enough to be stable and absorb the *recoil* (kickback) of firing but light enough to handle comfortably.

## Barrel

Barrel length, like weight, will vary with the rifle's use and the shooter's size. A young man with his first .22 rifle will probably do better with a shorter barrel, around 18 or 24 inches. A larger or more experienced shooter selecting a more powerful rifle may prefer a barrel that is 24 to 29 inches in length. The situation in which the gun will be used is another consideration. On a rifle that is to be used in heavy brush or woods, a shorter barrel is best. A target rifle or one to be used in open country would be better if it had a longer barrel.

## Stock

Proper stock fit is very important in the selection of a rifle. A stock that is too short will make the shooter feel cramped, and the shooter may place the rear sight too close to the face. A stock that is too long will put the weight of the gun too far away from the shooter and will force him to stretch to operate the gun. Since most guns are made for the average adult, a Scout will often need the stock shortened to make it fit well. This is usually easily done by any competent gunsmith.

A quick and easy test to see if the stock is the right length for you is to bend your arm at the elbow and place the butt of the rifle into the crook of your arm. In this position you should be able to comfortably reach the grip and trigger. If you can't, a gunsmith can add a spacer to the butt or cut off part of the stock to make the length right for you.

The comb of the stock is important, too. A comb that is too high will prevent you from properly aligning your eye with the sight. A comb that is too low will force you to raise your cheek up off the stock to see the sight. Both of these are detrimental to good shooting. Unfortunately, fixing a poorly fitting comb can be difficult and expensive. To begin with, it is best to select a rifle with the proper comb height. When you're checking comb height, remember to consider the type of sights you will be using. A scope will require a higher comb than field sights.



**Measuring stock fit**





The adult rifle in the photo *at left* is too big for a young person to successfully shoot from any position. The smaller rifle, *at right*, is better suited to the younger shooter's needs.

## Sights

The intended use of the rifle also determines the type of sights you need. For hunting, most people choose a scope in the 3- to 6-power range. Target shooters typically use aperture (peep) sights that are easily adjusted. A recreational shooter might prefer an open (field) sight that is more economical. Other shooters may select specialized sights that are made for their particular type of shooting. No matter what type of sights you choose, make sure that you can easily adjust them to *zero-in* your rifle. (This technique is explained later in the pamphlet.)

---

Buy a gun that fits you. A gun that fits well lets you shoot your best.

---

## Before You Buy

Answer these questions before making a final choice. If you are thinking of buying a used gun, take additional care in making the decision.

- How do you plan to use this rifle? Is the use multipurpose or specific?
- What are the best caliber, weight, and sights for this use?
- Is ammunition readily available? How much will ammunition cost for the amount of shooting you plan to do?
- How much money can you spend for the rifle?
- Have you done your homework? Have you studied manufacturers' catalogs?

- Have you inspected and handled the different types of rifles available?
- Have you checked the accessories and special features options?
- Can accessories be easily added to accommodate any changes in your shooting interest?
- Is the rifle simple to operate and to clean?
- Can the sights be easily adjusted?
- Does the rifle fit you?
- Have you read the warranty or guarantee?
- Is the rifle produced by a known manufacturer? Buying quality brands generally ensures the availability of future repairs and a good return on your investment.
- Does the rifle have a good record for dependability?
- Are you buying from a reputable dealer?
- What is the marketability if you decide to sell the rifle? Could you get back most of your money in a sale?
- Have you taken your time in making your decision? Remember: The chances are good that you will keep the rifle for life.

### **Buying a Used Rifle**

Here are some additional points to consider when buying a used rifle.

- Locate the previous owner, if possible, and find out why the rifle was traded or sold.
- Be aware that a poor outward appearance on a rifle generally indicates abuse or excessive wear.
- Have a gunsmith look at the rifle and determine if it has been misused.
- Check the bore for bulges or excessive wear.
- Check screw slots to determine if they have been abused during disassembly by an inexperienced person.
- Check the trigger for consistent pull and smooth function.
- Check the safety to determine if it functions properly.

- Secure advice from a gun expert regarding this rifle's market value.
- Check the wood in the stock for type, quality, and hairline cracks.
- Shoot the rifle before you buy it.
- Be certain the seller legally owns the rifle.
- Remember that you usually get what you pay for!

Note that rifles in original, unaltered condition tend to hold their value.

## Using a Borrowed Rifle

You may be able to use a rifle range in your town or at Scout camp. There, you will probably use a rifle provided at the range. This is fine. If possible, sight-in your borrowed rifle to your satisfaction.

## Sighting-In Your Rifle

You will *sight-in* your rifle whether it has come directly from the manufacturer or has been used by other people. This is also known as *zeroing* the rifle. "Zero" is sight adjustment that will allow the bullet to strike the target at the desired point of aim. To sight-in your rifle, follow the steps outlined in "Firing Your First Shots."

# Air Rifles

Air guns are not toys. Today's air gun is a technically sophisticated and precise instrument. Everything in this merit badge pamphlet—on safe gun handling, shooting positions, fundamentals of firing a shot, hygiene, and etiquette—applies to the use of air guns. Additionally, the advice given for purchasing a gun also applies to the purchase of an air gun. However, the procedures for cleaning an air gun differ.

Air guns are relatively inexpensive. They range in price from about \$100 to more than \$1,500. The ammunition is much cheaper than the cartridge type.

## Pellet Guns

The air rifle (pellet gun) fires a skirted lead pellet at varying velocities from about 300 to about 850 feet per second. Because they have velocities less than the .22 caliber cartridge gun, these gas and air guns are shot at a distance of 25 yards or less. In most organized programs, air rifles are shot at 25 feet on the NRA TQ-5 target or 33 feet (10 meters) on the NRA AR 5/1 or AR 5/10 targets. These targets are sized so that the challenge of meeting the shooting requirements is comparable to the .22 caliber rimfire rifles shot at 50 feet.

There are four types of air rifles: spring-operated, precompressed, carbon dioxide, and compressed air. Air rifles are virtually recoilless (they don't "kick"). The spring-operated air rifle was popular for many years and uses several types of systems. In the most successful spring-operated system, the barrel and action recoil freely to the rear when the piston and spring are moved forward. A more modern gun uses a precompressed system—the shooter cocks the rifle using a long lever and at the same time compresses air in a chamber that is released when the trigger is pulled. The carbon dioxide type is an old idea using a carbon dioxide cylinder that allows for a short burst of gas under pressure that propels the pellet through the barrel. A newer system uses compressed air as the propellant (the same system divers use). The gun's compressed air cylinder is filled from an air tank and installed in the gun the same as the divers' CO<sub>2</sub> system.

Air rifles are used in recreational and competitive shooting, field shooting, and silhouette shooting. The 10 meter (33 feet) air rifle event is a recognized event in national and international competitions including the Olympic Games.

One of the newest and fastest growing air rifle events in the United States is position air rifle. Position air rifle is normally shot in the prone, standing, and kneeling positions at 10 meters (33 feet). (See “Shooting Positions.”) There are two categories of position air rifle shooting: precision and sporter. Precision air rifle mostly emulates smallbore rifle shooting, using the same equipment and an expensive air rifle. Sporter air rifle is shot in street clothes using a low-cost air rifle. This type of air rifle shooting is shot widely across the United States and is recognized by the National Rifle Association for national records.



**The BB gun is not a toy—nor is any air gun.**



**Pellet guns fire skirted lead pellets.**

## BB Gun

The BB gun is usually a spring-piston model and is the simplest and least expensive of all rifles. It operates by a lever that compresses a spring that has a piston attached to it. When the trigger is pulled, the spring releases the piston and sends a blast of air up the bore behind the BB.

The bore of a BB gun is not usually rifled, so accuracy drops off as distance to the target increases. The average muzzle velocity of the BB gun is around 300 feet per second. This velocity gives good accuracy at short distances. The BB gun is shot at 15 feet for most organized types of shooting, including qualification programs and competition.

Always wear eye protection when shooting a BB gun. Steel BBs can ricochet off wooden or metal target frames, causing injury and property damage. It's best to hang BB targets from a string suspended between two posts, secured at the top and bottom.

## Advantages of Air Guns

The advantages of air rifles include low cost, lack of noise on firing, little or no recoil, and the shortened distance needed between the firing line and the target, which makes these guns great for use in a large room or outdoors.

An air gun is an excellent way to practice at reasonable cost, and an air rifle certainly can be used in fulfilling requirement 2 for this merit badge.

## Care and Cleaning

The care and cleaning of an air gun is a little different from cleaning a .22 caliber rifle. (See “Care of Your Rifle,” next.) Some cleaning solvents will harm air gun seals. Use a 100 percent synthetic solvent, which will not damage the rubber seals. Additionally, most air guns are to be cleaned from the muzzle, not from the breech end of the gun. In doing so, be careful not damage the muzzle with cleaning equipment. Carefully follow the manufacturer’s instructions for cleaning the gun.

The origin of the rifling is at the muzzle end of the barrel. This is the last contact of the rifle with the projectile. If the rifling is damaged by inserting the cleaning rod into the muzzle, the overall accuracy of the rifle will suffer. Instead, use a pull-through system made from strong fishing line.

# Care of Your Rifle

A rifle is a precision instrument. Like any other item of value, it must be cared for properly if it is to operate correctly and safely. Unlike many other items of sports equipment, a rifle is built to last a lifetime—and it will, if it is cared for properly.

## Cleaning

Make a habit of cleaning the rifle after each use. Regular cleaning will help ensure that the rifle functions properly, shoots accurately, and is reliable. Always thoroughly clean a rifle and apply protective lubrication before storing it. Cleaning helps preserve the finish and value of a rifle. Cleaning is also essential when a rifle has been stored for a long time or has been exposed to dirt or moisture. Be sure the rifle is cleaned thoroughly before use.

Before you begin to clean the rifle, point it in a safe direction, open the action, and **be absolutely sure that the gun is empty and all ammunition is removed from the area**. To assure safety, the action should be open during cleaning. Ideally, the bolt should be removed from the rifle during cleaning.



Six basic materials are needed to clean a rifle:

- Cleaning rod with attachment (*jag tip* to hold patches and a bore brush)
  - The rod must be the proper size for the bore of the rifle.
  - The use of a bore guide is recommended to help keep the rod in line with the bore.
- Cloth patches
- Bore solvent
- Gun oil
- Soft cloth
- Small brush



### Steps in Cleaning

**Step 1**—Pour a small amount of cleaning solvent into a small pan or cup, or use an applicator bottle. Screw a jag onto the cleaning rod, put a cleaning patch on the end of the rod, and dip the patch in the pan of solvent. Using a cleaning rod guide, push the rod through the guide and the barrel to loosen the fouling. (*Fouling* is the residue from burning powder and lead particles left in the barrel after a shot is fired.) Always push in one direction (action through muzzle). Remove the brush and pull the rod out of the rifle. Take off the jag and screw a bore brush onto the cleaning rod; dip the brush in the solvent pan. Repeat the same process used to run the patch through the barrel. (This technique keeps the residue out of the trigger mechanism and helps protect the barrel.) Remove the brush.

**Step 2**—Again, attach a patch to the cleaning rod and dip it into the solvent. Run the wet patch through the bore and remove it from the rod. (Do not pull the patch back through the barrel because you will cause residue to fall into the trigger.)

**Step 3**—Run a dry patch through the barrel in the same manner.

**Step 4**—To remove the loosened residue and fouling, run a series of dry patches through the barrel until one stays clean. Repeat steps 1 through 4 until the patches come out clean.

**Step 5**—Push a lightly oiled patch through the bore.





**Step 6**—Properly dispose of the unused solvent. Do not pour the unused solvent back into the solvent container because it may contaminate the clean solvent.

**Step 7**—Using a small brush (old toothbrush) or cloth, clean remaining parts of the rifle and remove any foreign material such as unburned gunpowder or small particles of lead.

**Step 8**—Lubricate any moving parts of the rifle (see manufacturer’s recommendations).

**Step 9**—Wipe all exposed metal surfaces with a silicone or lightly oiled cloth.

**Step 10**—Wash your hands when you are finished to remove lead and chemical residues.

After the rifle is cleaned, handle the gun by the stock. (Fingerprints can cause rust on the metal parts of your rifle.) Be sure your ammunition is clean as well. Check it for foreign material before using it. (Once again, be absolutely sure that no ammunition is present in the cleaning area.)

If the gun is a type that is not fired by gunpowder, such as an air rifle, its bore must be cleaned regularly. Keep any gun clean and rust-free on all exposed surfaces. Follow the manufacturer’s instructions.

## Repairs

Beginning shooters should leave repairs to experts. If the rifle is not functioning properly, take it to a professional gunsmith or send it back to the manufacturer for repairs.

## Storing Firearms

Before you decide how and where to keep your gun and ammunition, consider safety, storage conditions, access by others, and your personal needs. Many people are naturally intrigued by guns, and the temptation to pick one up is very real for adults and children alike. That could spell trouble if the person is too young or inexperienced to handle the gun safely. Security is another factor. Unfortunately, guns are often desirable booty for thieves.



For all of these reasons, shooting equipment must be kept in a secure location. Many manufacturers offer fine wooden cabinets to display and secure guns. Some gun owners prefer to have their guns out of sight and out of reach. If you choose storage that requires a lock, keep the keys where casual visitors and youngsters can't get them.

Always store guns and ammunition so that they are not accessible to untrained or unauthorized people. When removing a firearm for handling or cleaning, always remember to follow the safety rules, and double-check to ensure that the gun is unloaded.

Ammunition should be stored in a cool, dry place. *Minimize the chance of an accident by storing guns and ammunition separately.*

# Ammunition

The types of ammunition available today are as diverse as the types of rifles. Different sizes and shapes of ammunition have been developed to fit every sporting need, but all modern rifle ammunition consists of four basic parts—the *case*, *primer*, *powder charge*, and *bullet* (projectile). Together they form a rifle *cartridge*.

- The *case* is the container in which the ammunition parts are assembled. A metal—typically brass—is used in its construction. Cases come in many sizes and shapes designed to fit matching firearms. There are two basic types—*rimfire* and *centerfire*. The basic difference between the two is the location of the primer.

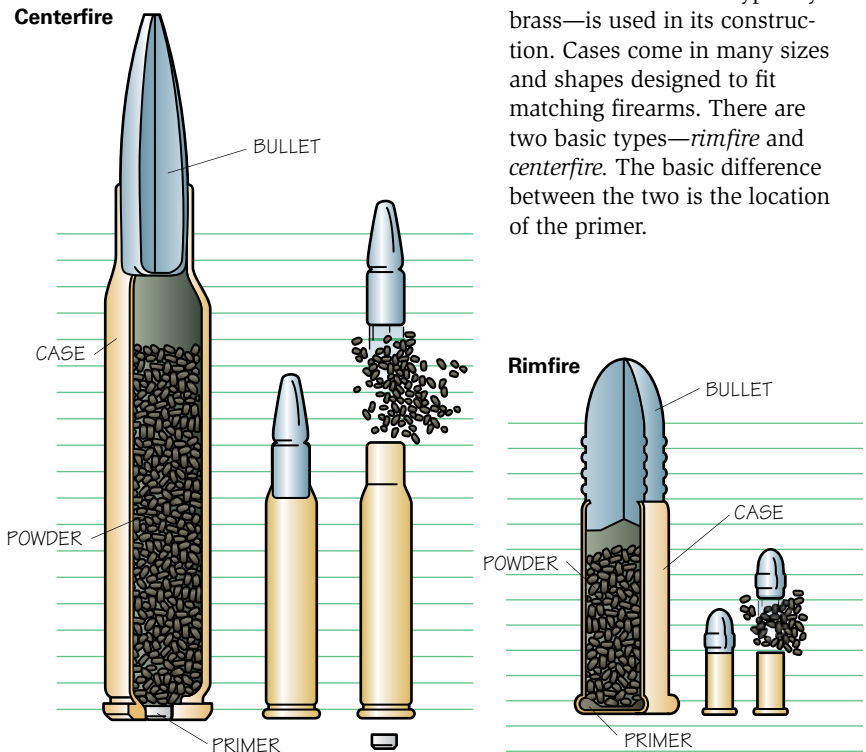

- The *primer* is an impact-sensitive chemical mixture that ignites when hit by the firing pin. In rimfire ammunition (mostly .22 caliber), the priming chemical is contained inside the hollow rim at the base of the case. The rim is soft enough that the firing pin leaves a small dent after striking it. This indentation crushes the priming compound, causing it to ignite. In centerfire ammunition, the primer is a separate component located in the center of the cartridge base. This type of design allows the greater case strength required in high-power rifle ammunition.
- The *powder* (a chemical compound) is a propellant. When ignited by the primer, the powder's gases expand rapidly and produce a high pressure, providing the force needed to propel the bullet through the barrel and to the target.
- The *bullet* is the projectile that is shot by the rifle at the target. It normally is made of lead and may also have a jacket of hard metal such as copper. The bullet must match the chamber and bore of the rifle, or an unsafe condition can result.

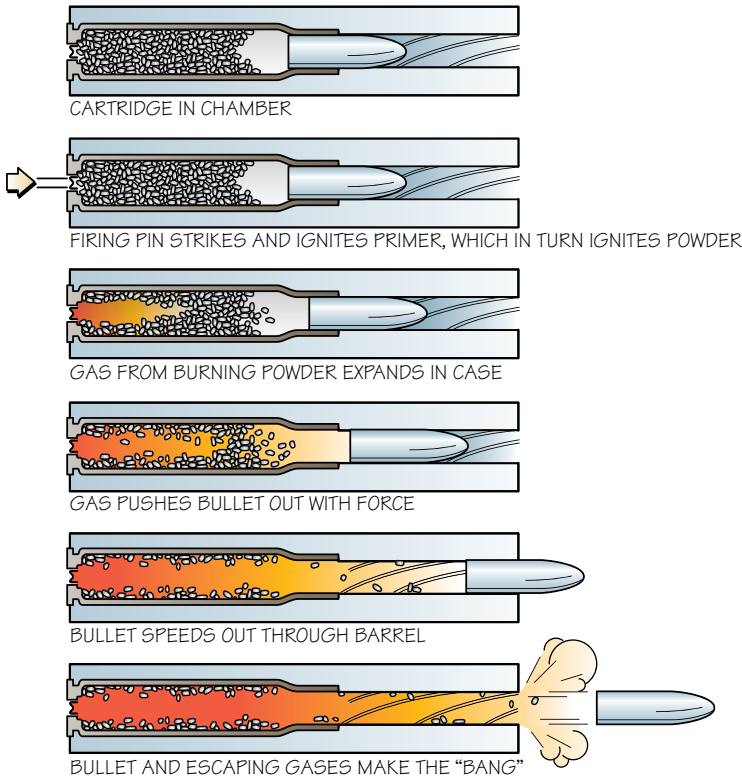

**How a rifle fires**

## Malfunctions

The three possible problems that can result from ammunition malfunctions are misfire, hangfire, and squib rounds.

- The *misfire* happens when a cartridge does not fire when the firing pin hits the primer. When this happens, *the shooter must keep the gun pointed in a safe direction and wait for at least 30 seconds before opening the bolt.* The misfire normally happens because the strike by the firing pin was too weak to fire the priming compound or because there was no priming compound where the firing pin hit the cartridge's primer.
- In rare cases, the priming compound will not ignite immediately but may ignite after a delay. Late ignition of the round is called a *hangfire*. The possibility of a hangfire is why the rifle is kept pointed in a safe direction for at least 30 seconds. At the end of that time, the bolt may be opened to remove the misfired cartridge or empty case.
- In a *squib round*, the primer ignites, but there are not enough gases to force the bullet out of the barrel.

In the rare instance that the round fired but did not sound right, nor did it hit the target, stop. Raise your hand if you are firing on a range, and explain the situation to the range safety officer. **Do not attempt to shoot another shot**, because the bullet may be lodged in the barrel.

The proper procedure is to remove the bolt and inspect the barrel from the breech end to determine whether the bullet is in the barrel. If the bullet is in the barrel, it should be removed from the barrel by pushing it with a cleaning rod *from the breech—never from the muzzle*. After removing the lodged bullet, clean the barrel to remove any residue and unburned powder.

---

If a cartridge fails to fire when the trigger is pulled, keep the rifle pointed in a safe direction. Because the cartridge might still fire, do not attempt to open the action of the gun for at least 30 seconds.

---

# Rifle Shooting Fundamentals

Once you know how a rifle works, how to handle it safely, and how to care for it, you are almost ready to shoot it. But there is much more to shooting than pulling the trigger.

Learning to shoot a rifle accurately is much the same as being introduced to any other skill. In soccer, for instance, the beginner is taught the basic skills—like kicking, passing, and shooting—before taking to the field and beginning actual play. It's the same with rifle shooting. To shoot a rifle safely and accurately, you must first learn the basic skills of the shooting positions and the shooting fundamentals. Once you have learned the fundamentals of rifle shooting, you can begin to apply them to various rifle-shooting activities for a lifetime of fun and challenges.

The *shooting position* provides a platform from which to accomplish the fundamentals of firing a shot. For this merit badge, you will learn how to shoot from a supported position (benchrest or prone supported position). This position will give you the best support, from which you can correctly learn the shooting fundamentals in the shortest time. (Shooting positions are described in more detail in the next chapters, “Shooting Positions” and “Firing Your First Shots.”)

## Determining the Proper Shoulder

Before you can get into a shooting position, you must determine whether you should shoot from the left or right shoulder. In shooting, this depends on whether you are right- or left-eyed, not whether you are right- or left-handed. To find your dominant eye:

- Extend your hands in front of you.
- Put your hands together and form a small opening between them.
- Keep both eyes open, and look through the opening at your instructor's nose. By looking through the opening in your hands, your instructor will quickly identify your dominant eye.



As an alternative method:

- Extend your hands in front of you.
- Put your hands together and form a small opening between them.
- Keep both eyes open, and look through the opening at an object in the distance.
- Move your hands backward until they touch your face, all the while keeping the object in sight.



The eye that is looking through the opening at the object is your dominant eye. If it is your right eye, you should shoot from your right shoulder (left eye, left shoulder).

## Shooting Positions

The shooting position is simply the posture of the body while shooting. The supported position forms the foundation from which you can learn the proper shot release technique. If your range has a benchrest, use it. If not, shoot from the supported prone position.

### Position of the Body

The position of the body is the arrangement of the head, torso, arms, and legs, and their relationship to the target. Positioning the body is the first step in assuming any shooting position.

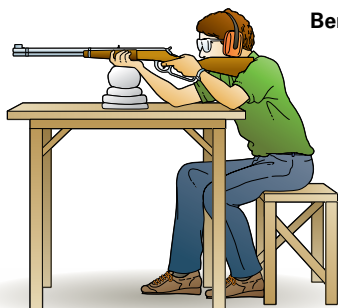

**Benchrest position**



LEFT-HANDED POSITION

RIGHT-HANDED POSITION



SUPPORTED PRONE POSITION

Three conditions are essential for a good position.

- First, be comfortable and relaxed. This means having as natural a body position as possible without straining.
- Second, provide maximum bone support. Use bones, not muscles, to support the body and rifle. If you rely mostly on muscles to support the weight of the rifle, you will tire quickly and you may have a hard time holding the rifle still.
- Third, align your position to the target. If these conditions are met, your rifle will naturally point at the target. The point where the rifle comes to rest when the body is relaxed is what shooters call *natural point of aim (NPA)*.

### Position of the Rifle

Correct position of the rifle involves the proper relationship of the rifle with the body. The rifle must be placed firmly against the shoulder so that the sights are aligned with the dominant eye, comfortably and naturally. Alignment of the sights with the eye, without tilting the head to the side, is essential to proper body position.

The fore-end of the stock should *rest* in the nonshoot-hand. Do not grip or squeeze the fore-end.

Correct hand and index finger placement on the rifle grip and trigger is necessary to correctly hold the rifle and pull the trigger. Grasp the grip of the stock with the lower three fingers, lightly resting the thumb on the top of the stock. Place the hand so that the index finger can pull the trigger straight to the rear.



**The trigger finger should be clear of the stock so it will not touch the stock while pulling the trigger.**



**Placement of the index finger should allow the trigger to be pulled straight to the rear.**

While relaxed, and without touching the trigger, notice through the sights where the rifle is pointing—where the rifle naturally wants to come to rest. If the rifle does not naturally point at the target, adjust your position around the sandbag or support to allow the rifle to naturally point at the target (natural point of aim).

### Fundamentals of Firing a Shot

Now that you have looked at the elements of a position, it's time to learn what it takes to fire a shot. It is important to understand that shooting is actually a series of one-shot events. Whether rapid-fire, as with a high-powered rifle, or single-shot, as with a single-shot smallbore rifle, the



fundamentals of firing each shot are the same. An expert shooter will recognize that each shot is a single event and will learn to use the fundamentals consistently for each shot.

The five fundamentals of firing a shot are

- Aiming
- Breath control
- Hold control
- Trigger control
- Follow-through

A shooter must accomplish each fundamental for each shot.

## Aiming

*Aiming*, simply stated, is the process of lining up the shooter's eye, the rifle, and the target. Aiming is done in two steps: *sight alignment* and *sight picture*.

- Sight alignment is the alignment of the eye, rear sight, and front sight. Consistent and proper sight alignment is necessary for accurate aiming. When using open sights with a post or bead front sight, sight alignment is correct when the front sight is centered in the rear sight notch and the top edge of the front sight is even with the top of the rear sight. With aperture or peep sights, sight alignment is correct when the front sight ring or top edge of the front sight post is centered in the rear sight aperture. When using a telescopic sight, proper sight alignment is achieved by positioning the eye to clearly see the entire field of view when looking through the scope.
- Sight picture is the relationship between the eye, the aligned sights or scope, and the target. Sight picture will vary according to the type of sights and kind of target being used. A bead front sight should be aimed at the center of the target. The top edge of a post front sight is centered on the bull's-eye or at the bottom of the bull's-eye (called a "6 o'clock hold"). When you have obtained the correct sight picture, the front sight should be clearly defined while the target and rear sight remain slightly out of focus. A scope reticle (usually crosshairs) is simply centered on the target and everything is brought into clear focus.

---

Unless designated otherwise, all position descriptions and photos in this pamphlet are for the right-handed shooter. Left-handed shooters will need to reverse this information.

---

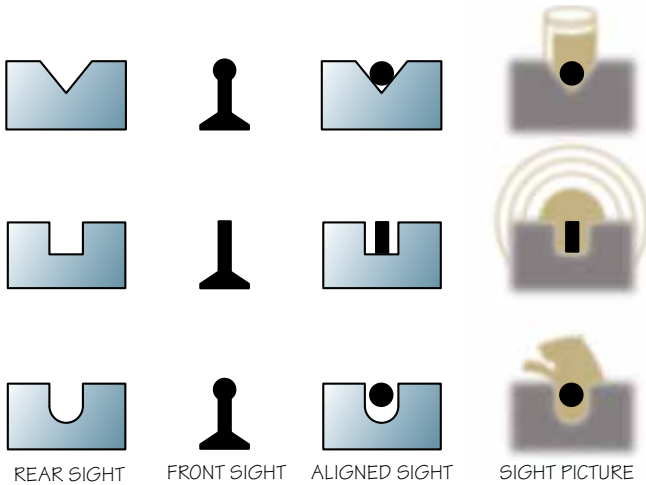

**Aiming with open sights**



**Aiming with aperture sights**

**Breath Control**

*Breath control* simply means to stop breathing before firing a shot. Breathing causes your body to move. Continuous breathing makes it difficult to maintain a steady sight picture. Before firing the shot, be sure you are comfortable and relaxed. Then exhale and stop breathing. This technique will help you in aiming by reducing the movement of your body and rifle in relation to the target. You should hold your breath no longer than about 8 to 10 seconds while aiming at the target. If you are not able to shoot the shot within that time, stop, take a breath or two, and repeat the process.

## Hold Control

*Hold control* means keeping the aligned sights or scope reticle aimed as closely as possible on the center of the target. It is the most important period in firing a shot. Even though you assume a proper and relaxed position and stop breathing, you will still notice movement in the sight picture. This movement is natural.

From a support, such as a benchrest, a shooter can come close to eliminating movement. You can minimize the amount of movement by concentrating on achieving the proper sight picture and holding as still as possible. You must learn to concentrate totally and consistently on sight picture control when firing.

Controlling sight picture movement is something that cannot be learned in one or two shooting sessions. All other fundamentals of shooting can be learned in a fairly short time, but hold control is practiced by championship shooters for years. However, you will notice rapid improvement in accuracy if you concentrate on achieving good hold control and practice this technique regularly.

## Trigger Control

To fire a good shot, pull the trigger straight to the rear when your hold is best—when it looks and feels right. Slowly squeezing the trigger while maintaining a good sight picture works much better than trying to quickly jerk the trigger to catch that instant when the sight picture looks just right.

There are two rules for good trigger control.

1. Pull the trigger while holding steady.
2. Pull the trigger straight to the rear smoothly and slowly, without disturbing your hold.

Remember to concentrate on hold control with your focus on the front sight.

## Follow-Through

*Follow-through* is maintaining position, aim, breath control, hold control, and trigger control before and immediately after firing the shot. Follow-through allows the rifle to recoil and return to its natural point of aim after the shot is fired. This will minimize the possibility of any sudden movement (just before the shot is fired) that will disturb the sight picture and radically change the bullet's path. If you remember where the bull's-eye was located in, or on, the front sight when the shot was fired and can tell your instructor where it was, then you have followed through. This is the process that shooters refer to as "calling the shot."

# Shooting Positions

The first consideration in any shooting activity is safety. Remember to observe the range rules and the basic rules of safe gun handling.

The shooting position is the platform from which the fundamentals of firing a shot are executed. There is one fundamental learning position with two derivations, and there are four basic shooting positions that rifle shooters use. Whether you are shooting competitively, shooting for recreation, or hunting, you will use one of these positions or some variation thereof.

As you learn to shoot, the best position to use is the “supported” position. The supported position is shot either from a table using sandbags to support the rifle or from the prone position using sandbags. Place the sandbags under the fore-end of the rifle. These positions will allow you to work on the fundamentals without distractions.

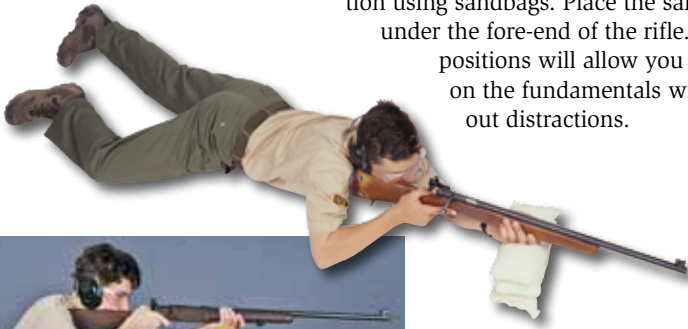

In all shooting positions, a *sling* (a strap normally made from leather or webbing) can be used to help support the rifle. With a properly adjusted sling, the muscles do not have to hold the rifle and can be relaxed, making the rifle steadier. In recreational shooting and hunting, a sling can be used in all positions. In competitive shooting, a sling is normally used only in the prone, sitting, and kneeling positions.

Rifle shooting is a precision sport. Learn to use the body to correctly support the rifle when you're firing a shot. In rifle shooting, the four basic positions are *prone*, *sitting*, *kneeling*, and *standing*. Each position has five basic elements that should be observed:

- Balance
- Support
- Natural point of aim (NPA)
- Comfort
- Consistency

If you are considering becoming (or are) a competitive shooter, you also need to make sure that your positions are legal (conform to the rules used during competition).

## Balance

Balance is a prime consideration in a shooting position. A good position places the weight of the rifle over the support points of the body. An erect head position is key to maintaining good balance. Keep your head erect and ears level to the ground in all shooting positions.

## Support

All shooting positions need to be built around the skeleton of the body. The skeleton is the structure that supports all the parts of the body. In shooting, the principle is to use the bones as much as possible to support the rifle. When building a shooting position, shooters must take into consideration their bones and muscles. Muscles will tire and quiver. Bones do not tire out, and they provide the most consistent support for the body-rifle system. A sling plays a major role in helping to support the prone, sitting, and kneeling positions.

## Natural Point of Aim

Natural point of aim (NPA) is where the rifle points when the body is at rest. A good shooting position will allow the rifle to point directly at the target, naturally, without any "muscling" by the shooter. NPA has three parts:

- **Bone support.** The bones must be used to support the rifle in all shooting positions because the muscles tire while the bones do not.

- **Relaxed muscles with sling support.** A sling, when used, supports the weight of the rifle in all positions (except standing for competitive shooters).
- **Alignment to the target.** The rifle naturally points toward the target with the body in a relaxed position supported by bone structure and very little muscle tension.

How do you check NPA? There are several ways. The following suggestion is one method.

- Relax in position with the head against the stock.
- Close the eyes for a few seconds.
- Open the eyes and see where the rifle is pointing.

How often should NPA be checked? Every shot.

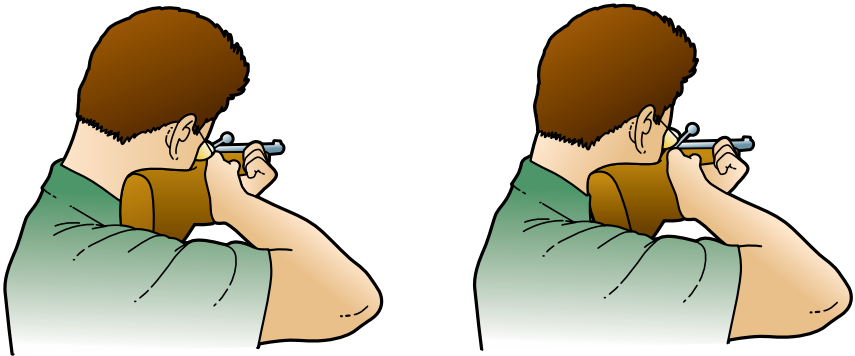

## Canting the Rifle

The shooting sports are in a constant state of change. Years ago, shooters thought that *canting* (tilting a rifle to move the rear sight in front of the shooting eye) was not acceptable. Over the past 20 years, shooters have learned that to shoot well, it is very important to make sure that the body is in a balanced position. That means that the rifle should fit the shooter and be brought to the shooter's position. It is more important to keep the head erect and tilt (cant) the rifle so the sights are in front of the shooting eye rather than to tilt the head to the sights. It is good to cant the rifle so the sights are in front of the shooting eye as long as you *cant consistently*.

## Comfort

The positions should be reasonably comfortable. A good position allows normal flow of blood between the heart and the body while firing. A good position requires the rifle and the body to be supported by the shooter's bone structure with little or no use of the muscles.

Stretching and flexibility exercises can help a shooter improve comfort. Remember that a Scout is physically strong.

## Consistency

Consistency is being able to do the same task over and over in exactly the same way. Why is this important? In shooting, you try to place one shot on top of another in the center of the target. The only way to accomplish the task is by having a solid position and executing the integrated act of firing the shot exactly the same way for each shot. If you're not consistent, your chance of firing each shot correctly in the same way is low.

## Attitude

Do you want to be a good shooter? The first thing you must do is be positive. No matter what position you decide to shoot, approach your task with the attitude that it is fun and easy. There is no "hard" position to shoot. Every position is easy, and you learn more every time you shoot from it. If you believe that something is difficult, then it is. Shooters who talk about one position being harder than another are actually teaching themselves that shooting is hard. Remember: Be positive.

**Note:** The following positions are described for a right-handed shooter. Reverse for a left-handed shooter.

## Standing Position

The standing position is the most natural and the most often used position. Standing provides the most clearance. It is the easiest position to assume, but it is the least stable for the beginning shooter.

### Position characteristics:

1. Shooter stands at about a right angle to the target.
2. Feet are about shoulder-width apart.
3. Knees are straight but not locked.
4. Body weight is distributed equally on both feet.



5. Back is slightly bent, with a slight twist above the waist, to compensate for the weight of the rifle.
6. Head is erect.
7. Right arm is relaxed.
8. The right hand grasps the grip of the rifle with about as much pressure as would be used picking up a milk carton.
9. The left arm rests against the rib cage and supports the weight of the rifle.
10. The rifle rests in the left hand with the fingers relaxed around the fore-end.
11. The butt of the rifle is positioned against the shoulder so the rifle sights are at eye level.





**Aligning the position (NPA):**

1. In standing, major changes to NPA horizontal movement are done by moving the feet. Minor changes are made by moving the toes.
2. NPA changes to elevation are accomplished by breath control or by positioning the feet in the stance wider or narrower.

**Prone Position**

The supported position (benchrest or prone) is the steadiest of the positions. The prone position is the next steadiest because it uses both elbows and almost all of the body in contact with the ground to provide a wide area of support.

**Position characteristics:**

1. The shooter lies facing the target about 5 to 20 degrees to the right of the firing position.
2. The left side of the body, forearm, upper arm, and left leg form essentially a straight line.
3. The right leg is drawn up with the lower leg parallel to the back and the right foot placed naturally on the ground. This action shifts the weight to the left side while raising the diaphragm off the ground to help breathing and reduce the effects of the pulse.
4. The left elbow is extended with the left arm forming about a 30-degree angle between the arm and the ground.





5. The rifle fits naturally in the left hand.
6. The right wrist is straight with the fingers relaxed.
7. The butt of the rifle is positioned against the shoulder so the rifle sights are at eye level.

**Aligning the position (NPA):**

1. The pivot point in the prone position is the left elbow. Major changes horizontally are made by shifting the hips left and right around the left elbow. Minor changes are made by slight movement with the hips.
2. Major vertical movement is made by moving the hips forward or back. If using a sling, the sling length can be changed to lower or raise the position. Make minor changes vertically with breath control.



## Kneeling Position

The kneeling position can be as steady as the prone position. Many good shooters in the competitive world shoot better scores in the kneeling position than they do in the prone position. This is also a good position in the field. It is quick to assume and steadier than standing, and it provides the clearance necessary to shoot over obstructions such as tall weeds or brush.

### Position characteristics:

1. The shooter sits on the heel of the right foot.
 

**Note:** If shooting on a target range at targets, use a kneeling roll. A kneeling roll is simply a bag filled with sand, rubber, or other substance that will provide support for the right ankle. It is placed under the instep of the right foot.
2. The head is erect.
3. The shoulders are almost square to the target (about 25 to 30 degrees to the right).
4. The back is bent slightly forward.
5. The left elbow is placed slightly over the left knee at the flat spot on the knee.
6. The lower left leg is vertical or slightly forward.
 

**Note:** This position places about 70 percent of the body weight on the rear heel, 20 percent on the left leg, and 10 percent on the right knee.

### Aligning the position (NPA):

1. Major horizontal changes are made by pivoting the body around the right foot (on the kneeling roll if one is used). Moving the left toe will help make minor changes horizontally.
2. Vertical changes are normally made using breath control or, if a sling is used, through a combination of breath control and sling adjustment.



## Sitting Position

Sitting is a common position used by high-power shooters and hunters. It is a stable position because it uses both elbows combined with a low body position. For hunters, sitting, like kneeling, provides more ground clearance than the prone position does.

### Position characteristics:

1. The shooter sits on the ground.
2. Legs are extended from the body with ankles crossed (left over right).
3. Shoulders are almost square to the target (about 15 to 25 degrees to the right).
4. Elbows are placed inside the knees.
5. The back is arched forward.
6. The rifle is placed in the left hand with the fingers relaxed.
7. The right hand grasps the rifle grip (straight wrist).
8. The butt of the stock is placed against the shoulder so that the rifle sight is at eye level.

### Aligning the position (NPA):

1. Major horizontal changes are made by pivoting the position left or right around the buttocks.
2. Vertical changes are normally made using breath control or, if a sling is used, through a combination of breath control and sling adjustment.

**Note:** Several other versions of this position are used in the field and by competitive shooters. This position gives the beginning shooter a starting foundation.

# Firing Your First Shots

Now that you know the basic shooting positions and the fundamentals of firing a shot, it's time to get into position and shoot.

## The Supported Position

The supported position (benchrest or supported prone) is the first position to learn because it is the steadiest and will give the best indication of the shot *groups* (pattern of shot-holes on the target) that will be fired. This position will support the body so that you can work on the shooting fundamentals. You should start this position from a table or from the prone position (supported prone) using sandbags for support. Sandbags are placed under the fore-end of the rifle. The support helps hold the rifle steady so you can maintain concentration.

There are five basic steps in learning any new shooting position. Use these steps to learn the supported position.

### STEP 1: STUDY THE POSITION

Look at the position. Learn what a good benchrest position looks like by studying the pictures in this pamphlet.



**Position of the body**



**Position of the rifle**



**Left-handed position**

## **STEP 2: PRACTICE THE POSITION WITHOUT THE RIFLE**

Learn to put your feet, legs, body, and arms in the correct position by getting into position behind the table, without the rifle. With the help of your merit badge counselor, do the following.

### **To get into position:**

- Take a seat at the table facing the target.
- Place your feet flat on the ground and lean forward, putting your elbows on the table. Your hips and shoulders should be aligned so there is no twist in your back.
- Make sure your left hand rests on the sandbag.
- Keep your head vertical and look at the target.
- Your position (without a rifle) should now look like the picture.

## **STEP 3: PRACTICE THE POSITION WITH THE RIFLE**

When you are in position and have the feel of it, add the rifle to the position. Again concentrate on becoming comfortable and familiar with the position. With the help of your merit badge counselor, do the following.

### **With the rifle:**

- Grasp the rifle grip with your right hand and rest your left hand on the sandbag.
- Lay the rifle across your left hand and against the shoulder so that the dominant eye can look through the sights comfortably and naturally without tilting the head to the side.
- Your position with the rifle should now look like the picture.

## **STEP 4: ALIGN THE POSITION WITH THE TARGET**

Ask yourself: “Is the rifle pointed at the target when I relax and look through the sights?” You are putting NPA to use. If the rifle is not pointed at the target, move your body left or right using your hand on the support as a pivot point. Adjust the position so that the rifle points to the target naturally (NPA). Do not “muscle” the gun to the target. With the help of your merit badge counselor, do the following.

### **Aligning the position with the target:**

- Make vertical adjustments by adjusting the height of the sandbag support.
- Make horizontal adjustments by moving your body left or right around the sandbag support on the table.

## **STEP 5: SHOOT FROM THE POSITION**

This is the final step in learning a shooting position because it tests everything you have done. You are now ready to begin the shooting process with dry firing.

## Dry Firing

The best way to learn the fundamentals of firing a shot is to begin with a dry run. Shooting an unloaded gun as though it were loaded is a process called *dry firing*. All shooters, from the beginner through the expert marksman, use the technique of dry firing. The best competition shooters know its value.

To dry fire, the shooter closes the rifle's action on an empty chamber, then practices the fundamentals of firing a shot as though the rifle was loaded. With help from your merit badge counselor, practice dry firing as follows.

- Get into position with your rifle, align your rifle (NPA) to the target, and make sure that you are comfortable and relaxed.
- When you feel that you are ready, begin aiming and stop breathing. Concentrate on eliminating the movement of your aligned sights.
- When everything looks and feels right, slowly squeeze the trigger straight to the rear until you hear a "click."
- Keep aiming after you hear the "click" (follow through).

Dry firing several shots will give you a feel for how much pressure is required to smoothly move the trigger without disturbing the sight picture. Total concentration on the sight picture, especially the front sight, is required.

(If you are dry firing a percussion muzzleloader, take steps to prevent damage to the nipple by placing one or two rubber or neoprene faucet washers over it. For more on this subject, see "Muzzleloading Rifles.")

If attempting to dry fire a rimfire or an air rifle, be sure to refer to the user's manual to determine if it can be safely fired without damaging the gun.

## Live Firing

Now try the real thing with live ammunition. Hang a target backward (no bull's-eye), or use a blank piece of paper for a target. Put on your eye and hearing protection. Begin with single shots on a blank target, followed by shooting three-shot groups.

At this point, you don't need to worry about where the groups are on the target. Your only concern should be to keep the group as small as possible by aiming at the center of the blank target. If you scatter your shots, check to make sure your sights are tight and that your barrel and action are correctly mounted into the stock. If the sights are tight and the action is correctly mounted, then do more dry firing and review the fundamentals.

After you have a good feel for the rifle and are comfortable with the fundamentals, hang a target correctly with the bull's-eye facing forward. Shoot another three-shot group. Try not to evaluate the shot groups by the scoring rings on the target. The size of the groups, no matter where they are on the target, will show how well you have applied the fundamentals of rifle shooting.

Continue shooting three-shot groups. When all three shots in your group can be covered by a quarter, adjust the sights to center the group on the target.

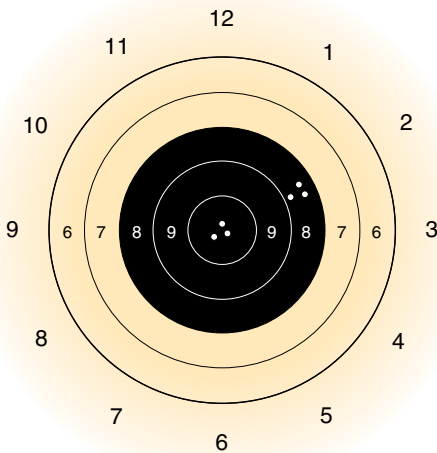

**The shot group in the center ring shows the results of zeroing the rifle. The first group of shots fired hit at 2 o'clock in the 8 ring, so the rear sight was adjusted down and to the left.**

a specific direction. Your merit badge counselor will also explain how to move sights that require tools such as a screwdriver.

Test your calculations by firing another group. The goal is to have the center of the group in the center of the target. Continue making finer adjustments until the group is in the center of the target. Also, remember that different ammunition, shooting distances, and shooting positions can change the zero and therefore require additional sight adjustments. When you can shoot the groups in the middle of the target, move up to shooting five-shot groups that are centered on the target.

## After Firing

Shooting is not over after the last shot is fired. After your last shot is fired *and the range is declared safe*, it is important to clean your firing point (pick up expended brass and all trash). If you are shooting your own firearm, clean it before you put the gun away. If you are using a borrowed gun, return it to the owner clean, or follow the rules of your summer camp or range. (Some programs might not want you to clean the gun because they clean their guns at the end of the day.)

## Sight Adjustment (Zeroing the Rifle)

Once you are shooting good groups with shots placed close together, you are ready to adjust your sights to move the shot group to the center of the target. The adjustment is made by moving the reticle or rear sight in the same direction you want to move your group. Another way to look at it is to “move your rear sight to the center of the target.” For example, if your shot group is high and left, move the rear sight down and to the right.

Most adjustment knobs are marked to show which way to move a shot in a particular direction. The instructions furnished with most sights will tell how far one click or gradation of sight adjustment should move a shot



## Shooting Hygiene

It is a good practice not to eat or drink when shooting. You should wash your hands and face after you shoot. It is also a good idea to change your clothes if you shoot for hours at a time. This is especially important in indoor ranges where lead dust tends to settle everywhere. If you don't practice good hygiene, you increase your chances of ingesting the lead dust and raising the lead content in your body. On outdoor ranges, dirt, dust, and the oils from your rifle and ammunition are good reasons for practicing good hygiene and keeping yourself clean. Remember, a Scout is clean.

## Shooting Etiquette

As a shooter in the 21st century, you face many challenges. Increasing urbanization, less available hunting land and fewer shooting ranges, and a growing anti-shooting sentiment make what you do as a shooter more visible to the public. Observing good etiquette and being a responsible shooter is an attitude that starts when you are first learning to shoot. All shooters need to act responsibly if the sport is to continue to grow. If all act responsibly, the sport will be preserved for future generations to enjoy.

As a shooter, you have a responsibility for safety and courtesy toward others. Shooters are among the most polite and responsible people of any sport. As a new shooter, you need to observe some "rules of etiquette": Remember to keep your voice low or not talk while others are shooting, immediately obey range commands, and always clean up your firing point.

Not only does etiquette apply as you are learning to shoot, it becomes more important as you grow in the shooting sport(s) of your choice. In hunting, for example, etiquette requires many of the things you have learned as a Scout. Try to leave both public and private lands in better condition than you found them. Remember the last time you walked your favorite trail and noticed cans and candy wrappers littering the ground? Responsible hunters know that litter is both ugly and environmentally destructive.

If you choose competitive shooting, you will quickly learn that being polite will help you shoot. You can offer to let another shooter share your shooting point and use your shooting mat and spotting scope. Not only is this polite, it keeps you from dragging your gear to and from the firing line. Offering to help the tournament sponsor can benefit you because you will learn how tournaments are conducted and you will be able to observe the good shooters and how they handle themselves.

# Scoring

When you have answered the questions and done the demonstrations called for in the requirements, you are ready for your shooting to be scored. The gun, the targets, and the distances vary in the options offered for the cartridge rifle, the air rifle, and the muzzleloader.

All shooting required for this merit badge is done from the supported benchrest or supported prone position. The objective of shooting is to place all your shots in one hole or get them as close together as possible. This is called *group shooting*.

Look at the qualifying scores in the requirements for this merit badge. The requirement for the minimum score using the rifle of your choice (.22 caliber or air rifle) is to fire five groups of three shots per group that can be covered by a quarter-sized ring. Using these targets, explain how to adjust the sights to zero a rifle. Then adjust the sights to zero and shoot another five groups with five shots in each group, each shot meeting the specified minimum score.

Individual shots score by touching a scoring ring area. Keep in mind that the bullet will push the paper in as it goes through the target. The hole in the target will be smaller than the actual bullet. You may need a *scoring gauge* or *plug* (a special metal gauge with plastic magnifier), which is inserted into the shot hole to accurately measure if the shot touched the scoring ring. Remember that shots are scored inward; that is, the shot hole is measured toward the center of the target.

**Note:** If it is not practical to adjust the sights of the rifle (i.e., when using a borrowed fixed-sight rifle), you may demonstrate skill in shooting fundamentals by shooting five shot groups (five shots per group) that can be covered by a quarter or touched by a quarter, and then explain how to adjust the sights to zero the rifle used.

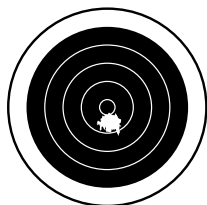

**Shot on a target touching a scoring ring**

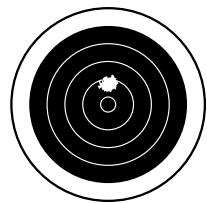

**Shot on a target in a scoring area, but not touching a scoring ring**

# Olympic Games and Shooting

Olympic-style shooting evolved from the European tradition of shooting. There are uniform courses of fire, and strict regulations govern the firearms, clothing, and equipment used in international competition.

The following rifle sports are fired in the Olympic Games.

## Air Rifle

With separate events for men and women, air rifle shooting joined the Olympic program in 1984. Competitors stand and shoot lead pellets from .177 caliber guns at targets 10 meters away. The bull's-eye, or 10-ring, is one-half millimeter wide, the size of the period at the end of this sentence.

**Guns:** By international regulation, air rifles can be either air- or gas-powered and weigh up to 12 pounds.

**Course of fire:** Men take 60 shots in 1 hour 45 minutes. Women take 40 shots in 1 hour 15 minutes.

**Perfect match score:** For men, 600 is perfect and 592 is world-class. For women, 400 is perfect and 395 is world-class.

**Finals:** The top eight competitors advance to a 10-shot final round, with 75 seconds allowed per shot. The final is calculated in tenths of a point and added to the match score to determine winners. A perfect final score is 109. A perfect aggregate (match plus final) score is 709 for men, 509 for women.

## Free Rifle Prone

This men's event has been on the Olympic program since 1896. Athletes lie on their stomachs and shoot .22 caliber rifles at bull's-eye targets 50 meters down-range. The target's center is 10.4 millimeters wide, smaller than a dime.

**Guns:** Athletes use elaborate rifles that have metallic sights (nonmagnifying sights) and can be customized with special accessories and alterations that fit the shooter's needs and comfort.

**Course of fire:** 60 shots in 1 hour 15 minutes.

**Perfect match score:** 600 is a perfect score; 597 is world-class.

**Finals:** The top eight shooters advance to a 10-shot final, with a 45-second time limit per shot. The final is scored in tenths of a point and added to the match score to determine winners. A perfect final score is 109. A perfect aggregate (match plus final) score is 709 points.

## Three-Position Rifle

In the three-position event (also called  $3 \times 40$ ), athletes fire .22 caliber smallbore rifles from the prone, standing, and kneeling positions, in that order, at targets 50 meters downrange. The bull's-eye is 10.4 millimeters in diameter. Today there are separate events for men and women. Until 1980, the three-position was an open Olympic event, meaning that men and women competed head-to-head.

**Guns:** Men and women use different types of smallbore rifles. Women fire "sport" rifles, which weigh up to 14.2 pounds, and men shoot "free" rifles (up to 17.6 pounds), which can be customized with special accessories or alterations. Both men's and women's guns have metallic (nonmagnifying) sights.

**Course of fire:** Men fire 40 rounds per position for a total of 120 shots. Time limits for men are 45 minutes for prone, 1 hour 15 minutes for standing, and 1 hour for kneeling. Women shoot 20 rounds per position for a total of 60 shots. They are allowed 2 hours 15 minutes for all three positions.

**Perfect match score:** For men, 1200 is perfect and 1165 is world-class. For women, 600 is perfect and 580 is world-class.

**Finals:** For men and women, the top eight performers advance to a 10-shot final round, fired entirely from the standing position with 75 seconds allotted per shot. The final is calculated in tenths of a point and added to the match point total to determine winners. A perfect final score is 109. A perfect aggregate score is 1309 for men; 709 for women.

## Running Target

Athletes stand and shoot .177 caliber air rifles with telescopic sights (not exceeding 4-power) at paper targets moving across a track 10 meters away. The target has two bull's-eyes spaced roughly 6 inches apart; an aiming dot placed between them aids the shooter in tracking. The 10-ring (the innermost ring of the black section of the target) on each bull's-eye is 5 millimeters wide, about the size of a pencil eraser.

Only men fire this event at world cups and the Olympics. Competition is open to men and women at U.S., continental, and world championships. Running deer and running game target, the 100-meter and 50-meter versions of this sport, were part of the Olympics at different times between 1900 and 1988. Today's 10-meter event replaced running game target on the Olympic program in 1992.

**Guns:** Shooters fire .177 caliber rifles that use air or gas to propel lead pellets downrange. This is the only shooting event in which competitors are permitted to use telescopic sights—4-power magnification or less.

**Course of fire:** The match consists of 60 shots divided into 30 slow runs and 30 fast runs. In slow runs, athletes have 5 seconds to track, aim, and fire at the moving target. In fast runs, the target is exposed for only 2.5 seconds. Shooters start with their rifles at hip level and can only mount their guns once the target is exposed.

**Perfect match score:** 600 is perfect; 575 is world-class.

**Finals:** The top six competitors advance to a 10-shot fast-run final. Finals are scored in tenths of a point and added to match scores to determine winners. A perfect final score is 109. A perfect aggregate score is 709 points.

# Muzzleloading Rifles

Much of the material in the earlier chapters of this pamphlet applies equally to all shooters. The material is not repeated in this chapter. Anyone involved in muzzleloading should read it.

## Muzzleloading Firearms: Background

Until the introduction of cartridge firearms in the 1800s, most firearms were loaded from the muzzle. Rifles that are loaded from the muzzle are called *muzzleloading rifles* or *muzzleloaders*. The firearm came from a discovery made more than 500 years ago. It was found that when a highly combustible material was confined and then lighted, the burning material created enough energy to send a projectile over long distances. This was the discovery of the basic firearm design.

The earliest firearms were crude and unpredictable. But, to the credit of their inventors, many of the major parts developed in the 15th century are still used today. Since their inception, firearms have consisted of three basic parts—the *lock* (the firing mechanism), the *stock* (the handle by which the gun is held), and the *barrel* (the hollow tube through which the projectile travels on its way to the target). These parts are discussed in greater detail below.

The evolution of the muzzleloading rifle spanned four centuries, over four basic phases: the matchlock, the wheel lock, the flintlock, and the percussion lock.

## The Matchlock

The matchlock is one of the earliest types of muzzleloading firearms. The name comes from a wicklike piece of material (called a *match*) that is lit before the gun is fired. When the trigger is pulled, the smoldering match is lowered into the *priming pan* containing loose gunpowder. (The priming pan is also referred to as simply the *pan*.)

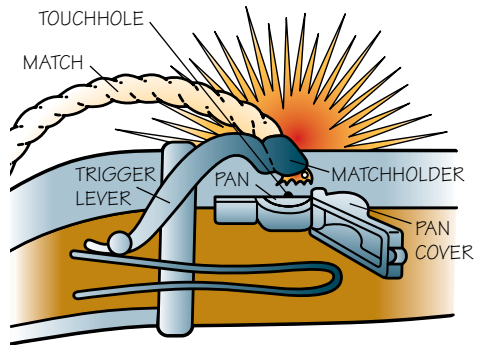

Matchlock action

The loose powder in the priming pan is called a *priming charge*. In ideal conditions, the match ignites the priming charge.

There is a very small hole between the inside of the barrel and the pan, called a *flashhole* or *flash channel*. The burning priming charge “flashes” through this hole and ignites the *powder charge* that has been loaded into the barrel through the muzzle. The ignition of the powder forces a ball of shot out of the muzzle with great velocity.

Down through history, shooters using this kind of firearm may have been excused for keeping their fingers crossed. If the priming powder got wet or the lighted match were put out, the gun would not fire. Weather conditions had to be perfect for a matchlock to operate properly. The first American colonists used matchlocks. Their use continued in Europe until the advent of the flintlock.

### The Wheel Lock

The successor to the matchlock was the wheel lock. It gets its name from a spinning wheel that makes a shower of sparks when a piece of *pyrite* (a spark-producing material) is brought into contact with it. The shower of sparks ignites the priming charge. The burning priming charge, in turn, ignites the powder charge in the barrel, which pushes the projectile out the barrel.

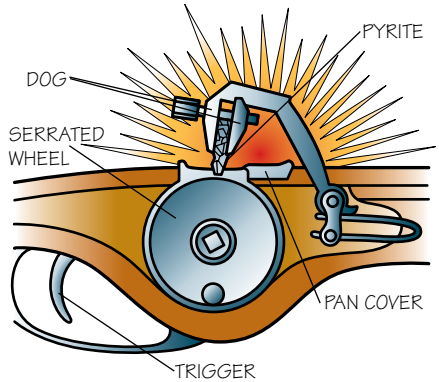

Wheel lock action

### The Flintlock

The next major step took place in the late 1600s with the development of the flintlock. With flintlocks, a piece of *flint* is secured between the jaws of the *cock*, or *hammer* as it is commonly called. The priming pan has a spring-loaded cover to protect the priming charge from getting wet. This cover is called a *frizzen*, and the upright steel plate at the rear of

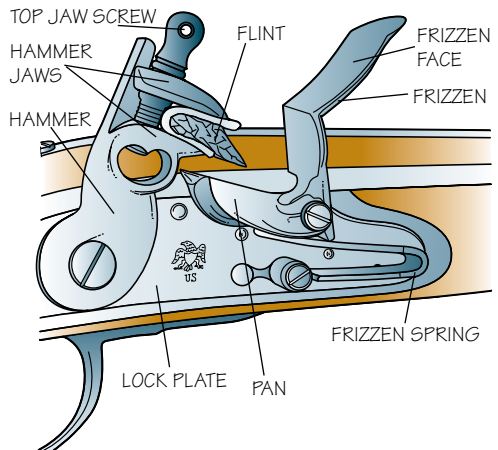

Flintlock action

the frizzen is called the *frizzen face*. Like the pyrite used on the wheel lock, the flint produces a shower of sparks when it strikes the frizzen face. When the trigger is pulled, the hammer snaps forward, striking the flint against the frizzen face, creating the sparks. As the flint contacts the frizzen face, the spring-loaded frizzen pops open, exposing the priming charge, which is ignited by the shower of sparks. The burning priming charge, in turn, ignites the powder charge in the barrel, which pushes the projectile out the barrel.

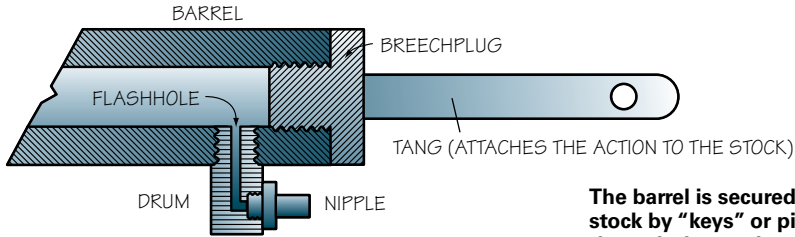
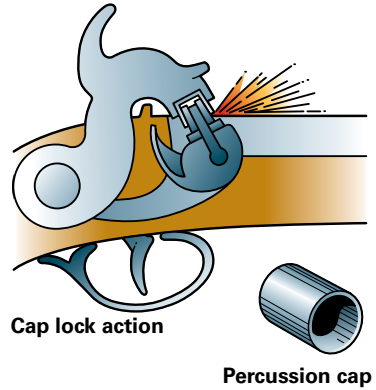

CUTAWAY OF THE UNDERSIDE OF A TYPICAL PERCUSSION BARREL

The barrel is secured to the stock by “keys” or pins through the stock.

## The Percussion Muzzleloader

The next major advancement in muzzleloaders took place in the early 1800s. During this era a compound called *fulminate of mercury* began to replace flints and black powder as a priming agent. This compound is contained in a small metal cup called a *percussion cap*. When the firearm’s hammer strikes the cap, the compound ignites, setting off the powder charge. Percussion caps were the forerunner to the modern cartridge primer.

Today the matchlock and the wheel lock are generally found as museum pieces or in the hands of collectors. They are so cumbersome and impractical that few shooters are interested in them beyond their historical value or as collectors’ items. Flintlock and percussion muzzleloaders are alive and well. There are many original muzzleloading firearms still being fired today. The popularity of flintlock and percussion firearms is great enough for manufacturers to make reproductions. These can be found in many sporting goods stores.



**Pennsylvania long rifle, a full-stock firearm also known as the Kentucky rifle**



**A musket, a military-style firearm**



**Half-stock mountain rifle, a shorter, more easily portable design. The ever-popular Hawken-type rifles are included in this category.**



Pictured are popular styles of muzzleloading rifles.

*In-line* rifles are a recent development. They get their name from the fact that their percussion lock mechanism is placed behind and in line with the barrel, rather than alongside it. They are popular with hunters because the *nipple* (the seat on which a percussion cap is placed and detonated) and percussion cap are covered and thus protected from moisture, rain, and snow. Although they look like modern rifles, they function like any other muzzleloading rifle.



**In-line percussion muzzleloading rifle**

## Lock, Stock, and Barrel

You may have heard the expression, “Lock, stock, and barrel” frequently. Today it refers to the total of many parts. It’s an old expression. Our forebears used it to emphasize completeness. The fact that the rifle was the source of this old saying gives you some idea of the important role firearms played in America’s early history.

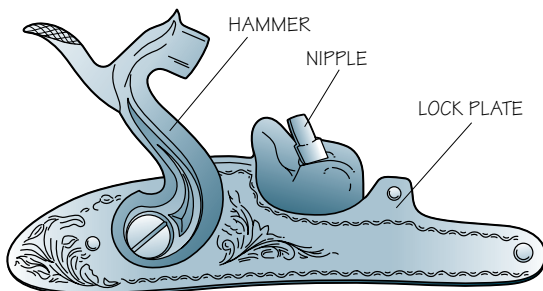

**Percussion lock plate, hammer, and nipple**

## The Lock

The lock of the muzzleloading rifle is the part that ignites the powder charge, causing the gun to fire. In today’s muzzleloading reproductions, the source of ignition depends on whether the gun is a percussion or a flintlock model.

In the percussion rifle, ignition is caused by the action of the cock, or hammer, striking the percussion cap. The cap contains a combustible priming substance that produces a very hot spark when struck and causes the powder charge to ignite. Pulling the trigger causes the lock to “trip,” thus setting off the desired chain reaction necessary for firing.

Most muzzleloading rifles have only a simple, single trigger. To fire, slowly and smoothly press the trigger straight to the rear until the hammer is released.

Some rifles have what is known as a *single-set trigger*. The rifle has only one trigger, but after cocking the hammer, push forward on the trigger until you hear a click. The trigger is now set, and only a very slight finger pressure on the trigger is required to fire the rifle. Single-set triggers can also be fired by simply squeezing to the rear without first setting the trigger, although considerably more pressure will be required on the trigger before it releases the hammer.

Some muzzleloading rifles are equipped with two triggers. This type of trigger mechanism is called a *double-set trigger*. After cocking, pulling the rear trigger causes the front trigger to be set. Only very slight finger pressure on the front trigger will then release the hammer and fire the rifle. The rifle may also be fired by pulling only the front trigger, although considerably more finger pressure will be required.

## The Stock

The stock is the handle by which the rifle is held. Stocks come in a variety of shapes and sizes designed to allow secure holding and handling under various shooting conditions.

Each area of the stock has a special name. Here is a review of terms.

- The *butt* is the part that is placed against the shoulder.
- The *wrist* is the area where the hand grasps the stock in order to pull the trigger.
- The *comb* is the top portion of the stock against which the shooter's cheek rests when the gun is held properly.
- The *forearm* is the front portion of the stock, which extends under the barrel.

## The Barrel

The barrel is the hollow metal tube through which the projectile passes when the rifle is fired. To review (see "Rifle Parts"):

- The *breech* is the rear-most end of the barrel. It is closed by a screwed-in part called the *breechplug*.
- The *bore* is the hollow space that runs the length of the center of the barrel. The diameter of this hole is measured in fractions of an inch or in millimeters. This measurement is called the *caliber*. A .50 caliber (read as "fifty caliber") rifle has a bore equal to 50 one-hundredths of an inch, or one-half inch.
- The *muzzle* is the end of the barrel through which the projectile leaves the rifle. On muzzleloading rifles, it is also the end from which the rifle is loaded.
- *Rifling* is a series of spiral grooves cut on the inside of the barrel that imparts a spin to the projectile as it passes through the barrel. This improves the stability of the projectile and promotes accuracy in the same way that spiraling a football makes it more accurate. Spinning a bullet (or a football) helps to keep it on its intended path. Most muzzleloaders have rifled barrels.

## The Powder Charge

The powder used in muzzleloading rifles is referred to as *black powder*. Black powder was first used around A.D. 1200 as a charge for rock-throwing cannons. It is still essentially unchanged after 800 years. Black powder is a simple mixture of chemicals that are easily obtained from natural sources. Although it looks similar, black powder is drastically different from the powder used in modern cartridges. The powder used in modern cartridges produces significantly more pressure than black powder and is never safe to use in muzzleloading rifles in any amount.

Only commercially manufactured, sporting-grade black powder or Pyrodex® offered for sale by a reputable firm should be used in muzzleloading rifles. The only safe substitute for black powder is Pyrodex®. It produces nearly identical pressure, bullet velocity, smoke, and noise. It may be used safely as a powder charge in percussion rifles. It is not recommended for use in flintlock rifles because of its difficulty of ignition.

Black powder usable in muzzleloading rifles will be found in four granulations:

- Fg Coarse-grain powder used in rifles of .75 caliber or larger.
- FFg Medium-grain powder used in large rifles (.50-.75 caliber).
- FFFg Used in small rifles (under .50 caliber), this is the finest-grain black powder safe for use as a powder charge.
- FFFFg This extra fine-grain powder should be used only for priming flintlocks and never as a main charge.



Fg

FFg

FFFg

FFFFg

Pyrodex

Fine granulations of powder burn quicker than do coarse ones. Rifles with a large bore (.50 caliber and greater) need slow-burning, coarse-grain powder. Rifles with bores less than .50 caliber need somewhat faster burning powder.

Black powder is an explosive, and special safety precautions must be observed whenever handling, transporting, or storing it. Because it is vulnerable to sparks and heat, black powder should be kept in a tightly sealed container. The 1-pound metal container it comes in is ideal. Do not use glass or plastic containers. The container must be stored away from heat. In some areas, there are local ordinances covering storage procedures for black powder. Carefully follow any laws in your area.

When you pour black powder from its container into a *powder horn* or flask, you must do so in an open, well-ventilated area. Never use an imitation horn (made of plastic) to store black powder. **Static electricity can be generated and cause ignition.** Never let anyone smoke near where you are handling black powder. Percussion caps and flints should be stored separately from black powder.

## The Projectile

Most muzzleloading rifles are designed to fire a projectile known as a *ball* (sometimes called a *round ball*). Other muzzleloaders, particularly muskets, fire *conical bullets* or *minié balls*. There are also several new types of projectiles that can be fired in a muzzleloading rifle and are used primarily for hunting.

A *round ball* is simply a sphere of pure, soft lead. Usually, there is a slight projection on the ball left from the hole in the mold through which the lead was poured. This projection is called a *sprue*. Round balls are highly accurate at short ranges and are preferred by target shooters and small-game hunters. Properly sized round balls are slightly smaller than the bore itself. Therefore, they require the use of a cloth *patch* wrapped around them to seal the gas from the burning powder behind them. The patch also fills the rifling and grips the ball so that the rifling is able to impart a spin on the ball.

A *minié ball* is a soft lead bullet with a hollow base. The base has a thin skirt that is designed to expand when the hot gases from the burning powder push against it. This skirt fills the rifling and seals the gas behind the minié ball. Since the skirt fills the rifling, no patch is needed. The minié ball gets its name from its inventor, French army captain Claude

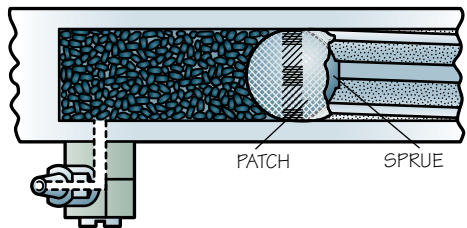

Round ball

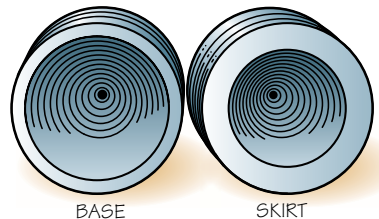

Minié ball

Minié, who developed it in the mid-1800s as an improvement over the round ball.

A *conical bullet* (sometimes called a solid-base conical) is a soft lead bullet with a solid base and two or more bands at the rear. These bands are slightly larger in diameter than the bullet itself. When the bullet is loaded, the bands cut into the rifling, sealing the base of the bullet and allowing the rifling to spin the bullet as it travels down the barrel. No patch is used with the conical bullet. It was designed as a further improvement over the minié ball. Conical bullets retain their energy over longer ranges than do round balls. Conical bullets are preferred for long-range shooting and hunting big game.

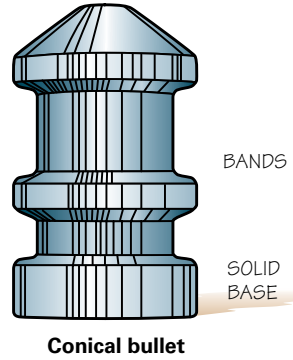

### Loading a Muzzleloading Rifle

Put a cartridge into a modern rifle's chamber, and it's ready to fire. The steps involved in loading a muzzleloader are considerably more involved. Special equipment and supplies are needed, both for loading and for cleaning the gun. These will be introduced as each step is described.

**Note:** Load at least 10 feet from the firing line to avoid sparks from others shooting.



**Items needed for shooting muzzleloading rifles, identified by number: (1) priming horn, (2) percussion caps, (3) patch material, (4) ball starter, (5) pregreased patches, (6) powder horn, (7) loading jag, (8) patch lubricant, (9) powder measure, (10) cleaning patches, (11) cleaning rod, (12) patch puller, (13) ball puller, (14) soft lead balls, (15) powder flask, (16) possible bag, (17) eye protection, (18) nipple pick, (19) ear plugs and case, (20) patch knife, (21) ear muffs, (22) nipple wrench.**

Depending on whether the rifle is designed to fire round balls, minié balls, or conical bullets, you will find the loading instructions slightly different. Regardless of the kind of projectile, however, the same step-by-step method must always be followed.

The basic steps in loading a muzzleloader are as follows:

- Clear the barrel.
- Measure the powder charge.
- Charge the barrel (pour the powder into the barrel).
- Seat the projectile.
- Prime the rifle.

Until you gain more practice, always have an experienced muzzleloading shooter or instructor with you when you are loading and shooting a muzzleloading rifle. This person can help with any problems you might encounter or questions you may have. Learning with the guidance of an experienced shooter makes learning easier, safer, and more fun.

The rules of gun safety that you learned earlier in this pamphlet apply to all firearms, including muzzleloaders. Also, there are some extremely important safety rules that you must follow when loading and shooting muzzleloading rifles.

## Safety Rules for Loading and Firing Muzzleloaders

- Always keep the gun pointed in a safe direction.
- Always keep your finger off the trigger until you are ready to shoot.
- Always keep the gun unloaded until ready to use.
- Know how the rifle operates before handling it.
- Know the target and what is beyond.
- Always wear eye and hearing protection.
- Wear a long-sleeved shirt or jacket and a hat made of *natural fibers*. Long sleeves and a hat will protect your skin from injury caused by sparks produced by the priming charge. It's important to wear clothing made from natural fibers (such as cotton or wool) for two reasons. First, synthetics, such as nylon, melt and stick to the skin when they burn, which can cause severe burns to the skin. Second, synthetics can also produce sparks from static electricity, which can ignite black powder.

Before loading, be sure to read and follow the manufacturer's instructions and loading recommendations for the rifle. Use the following steps as a general guide.

**Step 1—Position the rifle for loading.** Stand the rifle on the ground between your legs, with the muzzle pointed up and away from your body. When holding the rifle as shown, the arm used to hold the rifle should be extended enough to ensure that the muzzle is kept pointing up and away from the body. Never work directly over the muzzle.

Some ranges have special loading racks for muzzleloading rifles that hold the rifle upright while it is being loaded. If you use one of these racks, be sure to properly position the rifle so that it is held securely and kept pointed in a safe up-and-away direction.

On a percussion rifle, pull the hammer back slowly until you hear the first click and leave the hammer in this position. This should be about halfway between the down and *full-cock* positions. This halfway position is called *half-cock*. The nipple should not have a cap on it.



**Percussion rifle on half-cock**



**Position the rifle for loading.**

**Step 2—Check the bore for a load or obstruction.** Stored beneath the barrel of a muzzleloading rifle is a long stick called a *ramrod*. Draw the ramrod out of the *thimbles* that secure it and insert it all the way into the barrel, keeping your fingers from being directly over the bore. Mark the ramrod where it exits the barrel, using a pencil or by holding the ramrod between your thumb and forefinger. Remove the ramrod and place it alongside the barrel with the mark (or your thumb and finger) even with the muzzle. The tip of the ramrod should come very close to the nipple or flashhole. If the ramrod does not reach the nipple or flashhole, the gun may already be loaded! If there is any indication that the gun is loaded, have an experienced muzzleloading shooter or a gunsmith remove the load for you. *Never*



try to clear an old load by firing it. You have no way of knowing what was loaded into the barrel.

Once you are certain that the rifle is unloaded and the bore is clear, insert the ramrod down the barrel again as you did above. Now, permanently mark the ramrod where it exits the muzzle. Use a permanent marker or a pencil. Do not cut a notch into the ramrod, as this could weaken it, causing it to break and severely injure your hand.

With the ramrod permanently marked, you have a quick reference to determine whether the barrel is empty. Simply insert the ramrod into the barrel. If the mark is ever *above* the muzzle, you know that the bore is obstructed.



**Check the bore for a load.**



**Make sure the ramrod is against the face of the breechplug.**



**Measure against the outside of the barrel.**



**Wipe and clean the barrel.**

**Step 3—Wipe and clean the barrel.** Use your ramrod to run a clean patch up and down the bore. This will remove any excess oil from the bore that might interfere with ignition. With a percussion rifle, you may dry and clean the flash channel by firing two or three percussion caps on the nipple. Move to the firing line to do this. Wear eye and hearing protection. Be sure the range officer has approved your firing caps. Make sure the muzzle is pointed down range. When you fire the last of these caps, point the muzzle at a blade of grass or other lightweight object. If the object moves upon firing, you are assured that the channel is open.

**Step 4—Measure the powder charge.** Always use a *powder measure*. The powder measure helps assure the correct amount of powder in loading. Fill your powder measure to the appropriate level from the original can or your horn or flask. The gun's manufacturer can provide the recommended powder charge for that particular firearm. Never exceed the factory-recommended loading.

Some powder measures have a fixed capacity, while others are adjustable. Always be certain that you have the correct measure or that it is adjusted properly.

Powder charges are measured by weight in grains. A grain equals 1/7000 of a pound. The general rule is to use one grain of powder per caliber. In other words, an appropriate load for a .45 caliber rifle would be 45 grains of powder. BSA policy requires that Scouts do not exceed a load of one grain per caliber.

In casual shooting, you may want to use a reduced load. This will result in less recoil and noise and will make for a more comfortable and economical shot, with little or no effect on accuracy at close range. You may safely use as little as 35 grains of powder. As always, follow the manufacturer's recommendations.

Never pour powder directly from a powder horn or flask into the barrel. The inaccurate charge will result in inaccurate shooting, and if a spark remains in the barrel from a previous shot, an extremely dangerous explosion will occur.

Once you have measured the powder charge from the can, powder horn, or flask, remember to close the container. This is standard procedure for black-powder handling and an important safety rule.

**Step 5—Charge the barrel.** Holding the rifle in the loading position, use the powder measure to slowly pour powder down the muzzle into the barrel. This procedure is known as *charging the barrel*. To make sure that all the powder falls down to the bottom rather than clinging to the side, tap the side of the barrel several times with the heel of your hand. Be careful not to knock or tap against



**Measure the powder charge.**

a hard object. Tapping the side of the barrel with your hand by the lock also distributes some of the powder charge into the *drum* (the part that holds the nipple) on a percussion rifle, making ignition more reliable.

**Note:** If you are not shooting a patched round ball, go to step 8.

**Step 6—Prepare the patch.** As previously mentioned, round balls require the use of a patch. Not just any material can be used for a patch. A patch must be either 100 percent cotton or linen. The hot gases produced by the burning powder can melt synthetic materials. This can let gases blow past the ball while it is in the barrel, significantly reducing its velocity and accuracy. A synthetic material can also smolder in the barrel for a long time—creating a safety hazard when the next charge is poured—and it can be a severe fire hazard when it hits the ground.

The first step is to lubricate, or grease, the patch. Lubrication makes it easier to load the ball, provides a better gas seal, and makes the residue from the burning powder left in the barrel after the shot easier to clean. (This residue is called *fouling*.) Special lubricants specifically designed for this purpose are available. You can also use common cooking shortening. Patches are also available that are prelubricated and precut to a specific caliber.

To lubricate the patch, put a small amount of lubricant on your thumb and forefinger. Hold the patch between your thumb and forefinger, and work the lubricant into the fabric. The lubricant should be totally absorbed into the fabric. If any globs remain on the fabric, wipe them off. It is a good idea to prepare ahead of time as many patches as you think you will need. That way, your hands won't be greasy and slippery as you load and shoot.

If you are going to shoot immediately after loading, you may use a *spit patch*. A spit patch is lubricated with your own saliva. Just spit on the patch and work the saliva into the fabric. (**Safety note:** Be sure to spit on the patch rather than bringing the patch to your mouth and licking it. You will have powder, chemicals, and possibly lead on your fingers that you do not want to ingest.) A spit patch must be fired immediately. Leaving it in the barrel, even for just a few minutes, can put a rust ring in the bore and cause serious damage.

**Step 7—Patch the ball.** Place the lubricated patch squarely over the muzzle. Center a single ball directly over the patch with the sprue facing up.

**Step 8—Prepare the projectile.** (**Note:** If you are using a patched round ball, skip this step.) Minié balls and conical



**Charge the barrel.**



**Patch the ball.**

bullets need to be lubricated before they are loaded. Minié balls need only a very thin coat around the skirt and sides. The base may also be filled with grease to soften the fouling (see step 6), but too much grease in the base of the bullet can severely affect the bullet's stability on its way to the target.

If you are using a conical bullet, the space between the bands on the bullet must be completely filled with lubricant.

**Step 9—Start the projectile.** To start the ball or bullet, you need a special tool called a *starter* (sometimes called a *ball-starter* or *short-starter*). The starter has a wooden handle with two short rods protruding from it. The first rod is only about half an inch long. The second one is usually about 4 to 6 inches long.

Place the bullet's flat base directly into the muzzle and push it in as far as you can using just finger pressure, being careful to push it in straight. (Proper placement of the patched ball was described in step 7.) Place the shorter of the two rods on top of the bullet or ball and give it a sharp strike with the heel of your hand, driving it into the barrel flush with the muzzle. If you are using a patched ball, this will also wrap the patch tightly around the ball.



**Start the ball and patch.**

**Step 10—Trim the patch.** If you are using a precut patch or a bullet, this step will not be necessary. Otherwise, use a knife to remove any excess patch material protruding from the muzzle. Be careful not to scrape the muzzle with the knife.

**Step 11—Short-start the projectile.** Using the longer of the two rods on the starter, place the tip of it on the projectile. Drive the projectile into the barrel by tapping the wooden handle with the heel of your hand until the handle is at the muzzle. Remove the starter from the barrel and set it aside.



**Short-start the projectile.**

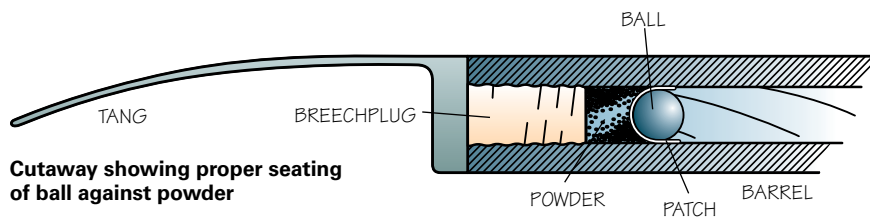

**Cutaway showing proper seating of ball against powder**

**Step 12—Seat the projectile.** Retrieve the ramrod. Place it into the muzzle, and grasp it no more than 8 to 10 inches above the muzzle. (**Safety note:** Grasping the ramrod further up might cause it to break, and you could stab your hand with the jagged, broken rod protruding from the barrel.) Push the ramrod down until your hand is at or near the muzzle. Again grasp the ramrod 8 to 10 inches above the muzzle and repeat this procedure until the projectile is firmly seated against the powder charge. You should encounter only slight resistance while you are pushing the projectile down the bore.

**Safety note:** It is vital that the projectile be seated firmly against the powder charge with no air space between the powder charge and the projectile. This is one of the most important safety precautions in shooting a muzzleloading rifle. Failure to properly seat the projectile can create a dangerous situation.

If you are always going to use the same load (the same amount of powder and the same type of projectile), you may want to mark your ramrod where it is flush with the muzzle while the tip of it rests on top of the load. You will then have two marks on your ramrod: one that shows when the barrel is empty, and one that shows when the projectile is properly seated on the powder charge.

If for any reason the projectile will not go down the barrel or seat firmly against the powder charge, it will have to be removed and the powder charge cleared. The procedure for removing a projectile is covered below. Never attempt to fire a load that is not firmly seated.



**Seat the projectile.**



**Mark the ramrod.**

**Step 13—Cap the rifle.** The final step in the loading procedure is to place a cap on the nipple. This should be done only when you are on the firing line and ready to fire. With the hammer still at half-cock, use a capper to place a percussion cap on the nipple. Be sure to seat it all the way down.



**Cap the cap lock.**

This is a general guideline. The steps to follow for any particular rifle can be found in the instructions provided by the manufacturer.

Now you are ready to shoot!

## Failure to Fire

Even if you have followed all of the steps carefully, the muzzleloader might not fire. You might just hear a “click,” or the cap may fire, but nothing else happens.

If the gun fails to fire, **keep it pointed in a safe direction and against your shoulder for at least two minutes.** Sometimes the powder charge will smolder for a few seconds, or as long as a minute or two, before igniting. This perceptible delay in the ignition of the powder charge is called a *hangfire*. When you have waited two minutes and have reduced the chance that a hangfire will happen, you may begin diagnosing the problem. **Be sure to keep the gun pointed in a safe direction during this entire process of diagnosis and projectile removal.**

- If the percussion cap did not ignite, remove it from the nipple, dispose of it properly, and wipe any visible debris off the tip of the nipple. Recap using a fresh cap, making sure to seat it all the way down on the nipple. Failure to seat the cap all the way down on the nipple is the most common cause for a cap failing to ignite.
- One of the most common causes of a misfire is a blocked flash channel. Run a fine wire through the nipple to make sure the channel is open. Then recap and try again.

Still no luck? The problem could be that there is no powder behind the ball. You might have forgotten to put in a powder charge. This is one reason for carefully following the same loading procedure every time. Let nothing distract you when you are loading. Remember: “First the powder, then the ball, or your gun won’t shoot at all.”

In a percussion gun, the problem of having no powder charge can be remedied by removing the nipple with a nipple wrench. (Work with your counselor in removing the nipple until you become proficient.) Once the channel is exposed, you can work enough powder behind the ball to enable firing. Reinstall the nipple, then reseat the ball with the ramrod. When you cap and fire this time, the ball probably will be expelled. If not, repeat the entire process, making sure, again, that the ball is resealed. If this will not work, you may need to pull the ball.

## Removing a Projectile

The simplest and safest way to remove a projectile is to use a carbon dioxide discharger. This device uses a common carbon dioxide cartridge attached to special adapters that fit over the nipple of a percussion rifle or into the flash channel of a flintlock. The projectile is discharged by the pressurized carbon dioxide. You must take care when using this device, as the projectile is expelled with great force. Keep the rifle aimed at a safe backstop and carefully follow the manufacturer's directions. Be sure to clean the barrel after the projectile has been removed and before reloading.

If you pull the ball manually, you must first **deactivate the powder**. There are several methods to do this. If your rifle has a removable barrel, remove it from the stock. Remove the nipple or flash channel liner and place the breech-end of the barrel in a bucket with at least 8 inches of water in it. Let the barrel soak for a minimum of one hour. After letting the barrel soak, you may also want to pour a small amount of water down the barrel to loosen any fouling in front of the projectile. This will make removal easier.

If your rifle's barrel cannot be removed, remove the nipple or flash channel liner, lay the gun horizontal or muzzle-down—ensuring that it is kept pointed in a safe direction—and fill the area behind the projectile with water. Let it soak for at least one hour.

Pulling the ball requires special tools. Most ramrods are not strong enough to pull a projectile from the barrel. A heavier rod, called a *work-rod*, should be used. An attachment that looks like a tapping screw, called the *ball-puller*, is attached to the end of the work-rod. Attach the ball-puller to your work-rod, push it down firmly against the ball, and screw the ball-puller into it.

It is preferable to use a work-rod with a T-handle so that you can place the "T" in the crotch of a tree or a vise, and pull the barrel toward you to remove the projectile. It is also sometimes possible to wrap a heavy leather thong around the work-rod, securing it with several clove-hitches, and wrap the other end around a tree or a stout post. You can then pull the barrel toward you to remove the projectile. Once the projectile has been removed, clean the barrel and reload. If the ball cannot be removed in this manner, take the firearm to a competent gunsmith.

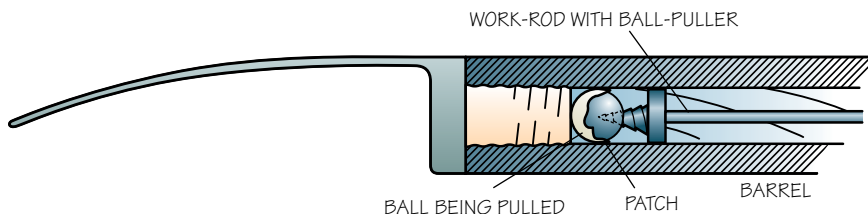

Cutaway showing how a ball-puller is used to remove a ball from a barrel

## Wiping the Bore

After firing, wait a minute before reloading to allow any sparks remaining in the barrel to burn out. Each time you fire a muzzleloading rifle, carbonlike residue is left in the barrel. After several shots this residue (fouling) can become so heavy that the gun will be hard to load. It can cause a ball to become stuck in the barrel during the loading process. For this reason, it's best to wipe out the barrel each time you fire a shot.

Wiping is easily done. A cleaning jag of correct size must be attached to the rod. Simply dampen a single cleaning patch—making sure the patch-jag combination is sized properly for a tight fit—and push it down the length of the bore several times. Then repeat this procedure with a clean, dry patch. Now you are ready for reloading a clean gun. Wiping between shots ensures that no sparks are left glowing in the bore from the previous shot, and accuracy is usually better if the bore is wiped between shots.

## Caring for Your Gun

Much of the information in the “Care of Your Rifle” chapter can be applied to the care of a muzzleloader. But caring for a muzzleloader requires a few special steps.

You can protect your muzzleloader by following a basic rule: *Never leave your rifle overnight without a thorough cleaning after shooting.* A simple solution of hot water and any conventional dishwashing soap or a bottle of cleaning solvent are virtually all you need to keep your gun free of harmful agents. Commercial black-powder solvents are effective in removing residue. The gun must also be lubricated frequently to protect its moving and stationary metal parts.

## Cleaning the Barrel

Muzzleloading rifles come in two styles. On one, the barrel can be removed from the standing breech. This is called the *hooked breech design*. In the second variety, the barrel, breech, and breechplug (or tang) are one piece.

The cleaning method depends on the style of your rifle. Muzzleloaders with a hooked breech design are cleaned fairly easily.

**Step 1**—Remove the ramrod.

**Step 2**—Bring the hammer to the full-cock position.

**Step 3**—Remove the nipple if the gun is a percussion firearm.

**Step 4**—Remove the barrel key from the forearm.

**Step 5**—Lift the barrel out of the stock.

**Step 6**—Using a cleaning rod with a cleaning end or a jag attached to its end, fit a soft flannel patch around the jag.

**Step 7**—Saturate the patch with cleaning solvent and wipe the bore several times to loosen the accumulated fouling.



**Step 8**—Insert the breech end of the barrel in a bucket of hot, soapy water.

**Step 9**—Stroking the rod in an up-and-down manner, “pump” water from the bucket through the full length of the bore. Repeat several times. Follow the procedure with a bucket of clean, hot water, repeating the pumping action until the barrel is clean.



**Position the hammer in full-cock position.**



**Remove the nipple.**



**Remove the barrel key from the forearm.**



**Lift the barrel out of the stock.**



**Insert the breech end of the barrel in a bucket or container of hot, soapy water.**

In cases where the breech, barrel, and tang are all one piece, they must be cleaned together. If your rifle is a percussion model, this can be done by using a flush-out nipple. This part is similar in size and shape to the “shooting nipple” that you use with percussion caps, but it has a larger hole for ease in cleaning.

Follow these steps:

**Step 1**—After swabbing the bore with a cleaning solvent or liquid soap, remove the shooting nipple and put a flush-out nipple in place.

**Step 2**—eight one end of an 18-inch section of thin plastic or rubber tubing (the kind used as fuel line in model airplanes is ideal).

**Step 3**—Attach the tubing to the flush-out nipple, making sure the fit is tight and snug.

**Step 4**—Insert the weighted end of the tube into a bucket of hot, soapy water so that the water is siphoned through the tube and into the rifle as the rod is gently moved up and down in the barrel.

**Step 5**—Maintain this action until the gun is thoroughly flushed. Then repeat the procedure with clean, hot water.

While you have the shooting nipple removed, clean it with soapy water. Use an old toothbrush to scrub the outside and a pipe cleaner to clean the inside channel. After you have thoroughly cleaned it, wipe it dry, oil lightly, and screw it back into the gun, replacing the flush-out nipple.

If you have a flintlock rifle, you won’t be able to use this technique. The one exception is the gun that is equipped with a removable flash-hole liner. In this case, the flashhole liner can be replaced with a flush-out nipple and the above procedure can be followed.

In all other cases, you must clean the barrel with a series of wet patches, using either hot water or a cleaning solution. The flashhole and the rear of the bore may be cleaned with a pipe cleaner.



**Clean the breech and barrel of your percussion model by using a flush-out nipple.**

## **Drying and Protecting the Barrel**

After you have thoroughly cleaned the barrel, use several clean, dry patches to wipe out the entire length of the bore. Continue to run patches on the inside until they come out clean and dry. Then wipe with an oily patch.

Don't overlook the outside of the barrel. Wipe and inspect all metal surfaces. Make sure that no moisture remains in such hard-to-get-at places as the breech and the thimbles that hold the ramrod under the barrel.

## **Cleaning the Lock**

The lock is usually held to the stock by two bolts. It can be removed from the rest of the rifle simply by unscrewing the lock bolts a few turns and tapping the bolt heads gently to loosen the lock plate. Then, unscrew the bolts the rest of the way and carefully remove the lock.

Once the lock is removed, use an old toothbrush to scrub both sides thoroughly. Don't hesitate to use very hot water—the hotter the water, the better the lock will dry. Make sure the mechanism is thoroughly dry. Then, lightly oil both the lock and the lock bolts, and replace the stock.

## **Cleaning the Stock**

The stock on your gun is probably made of a fine wood. You will want to keep it free of grime and powder. Powder solvents can hurt a wood finish, so be careful when using them. The stock can be cleaned with a damp cloth or a commercially manufactured stock finish, using a clean patch or cloth. When the stock is thoroughly dry, treat it with a light coating of stock oil or wax preservative.

Throughout the cleaning process, take extra care to ensure that no water or cleaning fluid spills into the space between the stock and the barrel. This moisture, undetected, can cause rust, the unfortunate source of damage to many a cherished firearm.

# Conservation and Hunting

Wildlife biologists have long recognized two key factors in game management:

- The first is that wildlife cannot be stockpiled like coal or oil. Any area of land, or *habitat*, can support only a certain number of wild animals. If a decision is made to have more game (wild animals for hunting) in a specific area and it is stocked with additional animals in excess of the biological *carrying capacity* of the habitat area, what will happen? In time, all animals in excess of the biological carrying capacity of the land will be eliminated by the natural factors of disease, starvation, emigration, or predation.

A **habitat** is the place where a plant or animal naturally or normally lives and grows.

**Carrying capacity** is the population of animals that an area will support without being damaged.

---

A **population** is all of the individuals of the same species that live in one place.

---

- The second important factor is that wildlife species naturally overproduce each year. That is, more young are produced than necessary to continue the species, and more are produced than the habitat area can support. The extra animals are lost to disease, starvation, emigration, or predation. This is nature's way of making sure that there are enough surviving animals each year for a breeding *population* and that the strongest strains survive for reproduction. For example, only 8 percent of young rabbits grow to breeding age.

These principles apply despite what people do with animals. If extra animals are put into an occupied habitat, more animals

than normal will die. If a few extra animals are taken by hunters, the remaining stock will soon bring the population up to a normal range.

Wildlife management experts try to arrange hunting seasons and bag limits (limits on the number of animals taken) so that hunters will harvest only the surplus. The hunting regulations they set ensure that hunters do not take too many animals. It is far better that hunters should get the healthful outdoor recreation and the meat by harvesting the surplus than to lose those surplus animals to disease, starvation, and other natural causes.

Without effective natural *limiting factors*, natural reproduction will cause an animal population to grow too large, and the result is damage to the habitat. For example, an unmanaged population of grazing animals such as deer will grow until its food and water supply will no longer support its members. In such situations, the large numbers of animals severely damage the plants in their habitat by overgrazing or browsing and by trampling the plants. Plants exposed to this kind of grazing pressure will not return to their former level of *productivity* for many years. The loss of productivity is equally harmful to other wildlife species with similar food and survival needs.

**A limiting factor** is anything that limits the survival, reproduction, or number of animals in an area.

**Productivity** in plants is the power to bear or yield food abundantly.

When it becomes obvious that a population is too large, it is important to increase the harvest and get the herd down to its biological carrying capacity. Game managers will often extend the hunting season and/or increase the bag limit to thin out the population. By harvesting animals that would otherwise be lost to causes such as starvation and disease, the hunter becomes a responsible participant in natural biological processes.

The real problem for wildlife is what humankind has done, and is doing, to the habitats where these animals must live. People are replacing woods, fields, and marshes with subdivisions, shopping centers, superhighways, industrial complexes, and airports. These changes lead to the destruction or alteration of habitats and to a smaller number of game animals.

(For more about these ideas, see the *Environmental Science* and *Fish and Wildlife Management* merit badge pamphlets.)

## Hunting Regulations

Each state has its own hunting regulations. These are issued by the state fish and wildlife agency, conservation department, or similar organization that is responsible for the state's fish and wildlife management program. You can get a copy of the regu-

In hunting language, **big game** usually refers to such animals as deer, elk, moose, antelope, and bear. **Small game** includes animals such as rabbits and squirrels. **Upland game** includes quail, grouse, partridge, and ptarmigan.

lations by writing to the correct department at your state capital. Locally, sporting goods and hardware stores that sell hunting and fishing licenses and equipment usually can supply a copy of the regulations. Your merit badge counselor can help you with this, also.

There are many differences in the state game laws. Hunting in Kansas is unlike hunting in California or New York. Differences in geography, human population, and game species call for different game laws. Even within a state, there will be some differences in game laws. Certain areas or counties may have different laws because of local conditions.

All states have regulations regarding the use or carrying of guns when hunting. These laws are designed to protect those in the hunting neighborhood. Such regulations may prohibit carrying a loaded gun in a car, shooting from a car, or shooting near buildings or roads. Many states control the type and caliber of gun that can be used for certain kinds of hunting.

The states require hunters to carry a hunting license. This helps them control the game harvest, and the license fees provide money for habitat improvement and game management. To get a hunting license for the first time, all states require the hunter to satisfactorily complete the hunter safety course initially developed by the National Rifle Association and now administered by each state's hunter education program. These courses are taught by volunteer instructors. (Several states "grandfathered" people born before a specified date, and those hunters were not required to take a hunter safety course. In other states, people who were licensed hunters in the state before a specific date established by law or regulation were not required to take a hunter safety course.)

Even if your state does not require you to take such a course, it is certainly worth your time to take it before you start hunting. You will find it interesting and informative. And if you have earned the Rifle Shooting merit badge, you will find it easy.

## Sportsmanship

Sportsmanship applies to all of shooting, whether recreational, competitive, or hunting. The true sportsman follows the Golden Rule: Treat others as you would like them to treat you.

- The sportsman knows and always follows the rules of safe gun handling at home, on the range, and in the field. He knows and strictly follows the laws regarding possession and use of firearms.
- The sportsman knows and follows the letter and spirit of the hunting regulations.
- The sportsman is considerate of the landowner whose property he may be using. He asks permission to hunt on the property. He does not litter the area with trash.
- The sportsman is careful of the target, both for safety and also to avoid senseless destruction. He does not shoot powerline insulators, pipeline valves, signs, or similar property. He confines his shots to proper targets.
- The sportsman is careful of the area beyond the target to ensure that bullets that miss the target or ricochet do not travel on to cause damage.
- The sportsman, when hunting in the field, gives fellow hunters a fair chance at game. The sportsman does not take unfair advantage of another shooter in any way.

The accomplishment of taking game during the hunt is only part of the experience. Enjoying the outdoors, seeing wildlife, and stalking game are also pleasurable parts of the hunt.

# What's Next?

The shooting sports are a popular recreational activity in America. Many people enjoy hunting or sharpening their skills at a shooting range. Tens of thousands of competitive shooters participate in shooting contests (matches), including those at the Olympic Games. In fact, shooting is the third most popular Olympic sport when ranked by the number of participating nations. It is exceeded only by Olympic track and field events and boxing events.

## Instruction and Qualification Programs

You can enroll in a basic shooting course for several types of shooting, including rifle, shotgun, and muzzleloading. Basic marksmanship courses are offered by NRA-certified instructors who will be able to help and guide you to better shooting.

After you have taken a basic course, you can continue to improve your shooting skills through the NRA Qualification Program. This program is a good way to test your shooting skills and earn medals, pins, and patches as your shooting skills improve.

## Shooting Clubs

One of the best ways to improve your shooting skills is to join a local shooting club and its junior shooting program. Juniors in these clubs shoot the NRA Qualification Program and participate in local, state, and national competitions. A local club is a great way to meet new shooters with the same interests and to travel to new places to test your shooting skills.

## Leagues and Championships

### Informal Competitions

**Postal matches** are competitions in which shooters fire at their home club ranges and send scores to the NRA for comparison with other scores sent in from around the country. The **Scout Camp National Postal Rifle Matches** is an example of a postal match that you can enter when you go to summer camp. It offers:

- National awards—for the categories of top three seniors (seasoned campers; age limit 17) and juniors (first-year campers; age limit 13)



- Camp awards—a Camp Rifle Champion belt buckle, awarded to the top-scoring individual in each category of senior and junior
- Weekly awards—NRA/BSA Camp Rifle Champion hat pins and certificates, awarded immediately to the top shooters in the senior and junior categories at the end of each week

## Tournament Competitions

The NRA sanctions more than 11,000 tournaments each year. Many are conducted specifically for juniors, but most are also open to adults. These competitions are a good way for you to test your skills and to learn more about competitive shooting. They are also the path to the Olympic Games.

## Special Activities

**NRA Youth Hunter Education Challenge (YHEC) programs** are sanctioned each year in the United States and Canada by the hunter safety coordinator in each state or province. The top finishers from these events are eligible to participate in the North American YHEC, which is held each summer. Young hunters also have the opportunity to earn awards for successful hunts in the Young Hunter Awards Program.

The **law enforcement Explorer shooting program** offers a qualification shooting course for use by the BSA's law enforcement Explorer program. The NRA also conducts a law enforcement Explorer shooting championship as part of the national law enforcement Explorer conference.

Camp programs offer one way to introduce young people to shooting. Not only do BSA local councils have shooting in many of their summer camp programs, but many private summer camps also have shooting programs. There are also special shooting camps sponsored by the NRA designed to improve the junior shooter's skills with the rifle. Shooting camps are conducted at the state and national levels for beginners, intermediates, and advanced junior shooters.

School programs are designed to educate high school students about shooting sports and to promote activities among school groups. Physical education classes, scholastic clubs, and competitive teams may be involved in any of the various shooting disciplines.

College programs are geared to shooting activities on the college level. These programs include competitive intercollegiate teams, student-run shooting sport clubs, physical education, and ROTC programs. Rifle shooting is an NCAA sport with scholarship opportunities available at several colleges.

Other activities are also available such as the Sighting-In Days Program, National Hunting and Fishing Day, and other types of junior shooting camps.

You can find out more about these and other programs by writing to the NRA at 11250 Waples Mill Road, Fairfax, VA 22030, or visiting their Web site at <http://www.nrahq.org/youth/> or <http://www.nrahq.org/safety/education/youth.asp>.

# Glossary

**action.** The group of moving parts that allow the shooter to load, fire, and unload a gun.

**aiming.** Aligning a firearm with the target.

**air gun.** A gun that uses compressed air or carbon dioxide to propel its projectile.

**ammunition.** The projectiles with their cases, primers, and propelling charges that are fired from guns; cartridges.

**aperture sights.** A kind of metallic sight that uses a small hole in the rear sight and a front sight with a metal or plastic insert with a post or a ring in it. To aim, the shooter aligns the front sight in the center of the rear aperture, placing the front bead on the target or placing the black of the bull's-eye in the center of the front sight ring.

**autoloader.** A repeating firearm. After it is loaded and cocked manually by the shooter for the first shot, the firearm then automatically loads a new cartridge from the magazine into the firing chamber and cocks itself for the next shot. *See also* semiautomatic.

**ball.** A round projectile. *See* round ball.

**ball-puller.** An attachment that looks like a tapping screw attached to the end of a work-rod, for screwing into an unexpelled ball and removing it from the barrel of a muzzleloading gun.

**ball-starter.** A short rod or peg used to start a ball or bullet down the barrel of a muzzleloading gun.

**barrel.** The tube through which the projectile passes. It has raised surfaces or ridges on the inside to impart spin to the projectile (*see* rifling).

**BB.** A copper-plated steel ball for use in a BB gun, a type of air gun.

**benchrest.** A table or other platform that forms a supporting base for a rifle and that allows the shooter to be seated while firing.

**black powder.** Gunpowder that burns explosively.

**bolt.** The sliding part in any breech-loader's action that guides a round into the chamber and rotates to tightly lock and prevent the action from opening upon firing.

**bolt handle.** The lever that the shooter pulls back to open the action on a bolt-action rifle and pushes forward to chamber a round and close the action.

**bore.** The interior of a gun barrel.

**breath control.** Not breathing while firing a shot in order to maintain a steady sight picture.

**breech.** The rear portion of a rifle, usually the rear opening of the chamber into the barrel.

**breechblock.** A movable block of metal that closes the chamber at the rear and supports the base of the cartridge case during firing.

**breechloader.** Any gun that is loaded from the breech, usually with a cartridge, as distinguished from a muzzleloader.

**breechplug.** A plug threaded into the breech of the barrel of a muzzle-loading gun, to seal the breech against the rearward escape of gases when the gun is fired.

**bullet.** An elongated projectile designed to be fired from a rifled barrel.

**bull's-eye.** The central blackened part of a target or the smallest center ring.

**butt.** The rear end of a gunstock.

**caliber.** The interior diameter of a gun barrel.

**calling the shot.** Predicting where the shot will strike the target based upon the sight picture at the instant of firing.

**cap.** See percussion cap.

**cartridge.** The complete unit of ammunition, consisting of projectile, case, powder (propellant), and primer.

**case.** The metal container, usually of brass, which holds ammunition parts.

**centerfire.** Cartridges having the primer in a pocket at the base of the cartridge case.

**chamber.** The rear portion of the gun barrel into which a cartridge is inserted for firing. "To chamber" is to insert a cartridge into the breech of a gun.

**charging the barrel.** Dispensing a specific amount of black powder directly into the muzzle of a firearm.

**clip.** A device or box holding cartridges; used in loading a magazine.

**cock.** The hammer of a muzzleloader. "To cock" is to place the hammer of a firearm in the firing position.

**comb.** The upper edge of a stock. The shooter's cheekbone rests on the comb.

**conical bullet.** A soft lead bullet with a solid base and two or more bands at the rear. The bands are slightly larger in diameter than the bullet itself and cut into the rifling, sealing the base of the bullet and allowing the rifling to spin the bullet as it travels down the barrel of a muzzleloading gun.

**crosshairs.** See reticle.

**double-set trigger.** A trigger mechanism that is set by pulling or pushing a first trigger, then released by a pull on a second trigger.

**drilling.** A gun with three barrels; for example, a side-by-side shotgun with a rifle barrel on top or a gun with side-by-side rifle barrels with a shotgun barrel underneath.

**drum.** A cylindrical piece of steel holding the nipple in a percussion rifle.

**dry firing.** Simulating shooting with an unloaded firearm, including cocking it and pulling the trigger; used to practice gun handling and control.

**elevation.** Vertical adjustment of a firearm sight to change where the bullet hits the target.

**falling block.** A kind of firearm action in which the breechblock drops into a well within the receiver to expose the chamber.

**firing line.** At a target range, the line along which shooters are positioned for firing at their targets.

**firing pin.** The device that strikes the primer in the cartridge, igniting the primer by causing an indentation that crushes the priming compound.

**flash channel.** A small hole between the inside of the barrel and the priming pan in a muzzleloading gun; *see* flashhole.

**flashhole.** A fire hole used in muzzleloaders; a small hole through the breech that runs from the ignition source to the powder charge.

**flint.** In a flintlock, the piece of stone that strikes the steel frizzen face to produce a shower of sparks, thus igniting the priming charge and, subsequently, the main charge in the barrel.

**flintlock.** A muzzleloader with a hammer, or cock, that holds a flint in screw-tightened jaws; having a frizzen, or striking plate; a pan in which the priming charge is placed; and a flash-hole through which the flame passes to the main charge in the barrel.

**follow-through.** Maintaining the correct sight picture even after firing, to ensure that the firearm remains in proper relationship with the target so as not to disturb sight alignment just before the shot is fired.

**forearm.** *See* fore-end.

**fore-end.** That part of a gun's stock forward of the action, extending under the barrel and providing a grip for one hand below the barrel.

**fouling.** The residue from burning powder left in the barrel after a shot is fired.

**frizzen.** In a flintlock, the spring-loaded cover of the priming pan, with an upright steel plate against which the flint strikes, producing the sparks that ignite the powder.

**frizzen face.** The striking surface of a frizzen.

**full-cock.** The position of the cock or hammer when ready for firing. *See* half-cock.

**fulminate of mercury.** An explosive used in some now-obsolete primer compounds.

**grip.** The part of the stock gripped by the firing hand.

**group.** The pattern of shot-holes on a vertical target.

**group shooting.** Shooting a series (group) of shots on a target.

**gunsmith.** A person who designs, makes, or repairs guns.

**half-cock.** A hammer position at the midpoint of hammer travel; an intermediate safety position for the cock or hammer. *See* full-cock.

**hammer.** The part that strikes the percussion cap in muzzleloaders or the primer in cartridge arms. Some hammers directly strike the cap or primer, while others strike a separate firing pin. The hammer on flintlocks is called the cock.

**hangfire.** A delay in the ignition of a cartridge at the time of firing, often described as the "click" of the firing pin being followed by a delay, then the "bang" of firing.

**hinge.** A type of rifle action that opens like the movement of a door hinge; when the release lever is pushed to one side, the barrel swings downward.

**hold control.** Keeping the aligned sights or scope reticle aimed as closely as possible on the center of the target, minimizing movement in the sight picture.

**hooked breech.** A style of muzzleloading rifle in which the barrel can be removed from the standing breech.

**in-line rifle.** A kind of percussion rifle in which the percussion lock mechanism is placed behind and in line with the barrel, rather than alongside it.

**jag.** The end of a cleaning rod, having grooves or ridges that grip a cleaning patch or swabbing material.

**knapping.** Shaping flint by breaking off pieces with quick blows.

**kneeling position.** A shooting position in which the shooter sits on the heel of the right foot, with the lower left leg vertical and the left elbow resting on the left knee.

**lands.** On the inside of a rifled barrel, the ridges, standing above the grooves, that make a bullet spin.

**length of pull.** The distance from the trigger to the rear of the butt.

**lever action.** A type of rifle action that is opened by pulling the cocking lever downward and forward away from the stock.

**live firing.** Shooting with a loaded firearm, using live ammunition.

**load.** A particular combination of case, primer, powder, and projectile. "To load" is to charge a firearm with ammunition.

**lock.** The firing mechanism of early firearms (*see* flintlock; matchlock).

**magazine.** In a repeating firearm, the container in which cartridges are stored before loading, one by one, into the chamber.

**match.** The fuse, wick, or smoldering cord used in matchlock firearms.

**matchlock.** A muzzleloader in which a lighted match is touched to the powder in the priming pan, igniting the priming charge, which in turn shoots its flame through the flashhole to set off the powder charge in the barrel.

**metallic sight.** Nonmagnifying devices on the front and rear ends of a firearm used in aiming. *See* sights.

**minié ball.** A soft lead bullet with a hollow base. The base has a thin skirt that expands when hot gases from burning powder push against it, filling the rifling and sealing the gas behind the bullet.

**misfire.** The failure of a round to fire.

**musket.** A military shoulder arm, either flintlock or percussion.

**muzzle.** The forward end (mouth) of the barrel, through which the projectile exits.

**muzzle velocity.** The speed of the projectile measured as it leaves the muzzle of the barrel.

**muzzleloader.** Any gun that must be loaded through the muzzle by charging first with black powder, followed by the lubed or patched projectile.

**natural point of aim (NPA).** The point where the rifle comes to rest when the shooter's body is in a relaxed, natural position.

**nipple.** The cone-shaped seat on which a percussion cap is placed and detonated by the hammer of a muzzle-loader. The nipple has a hole through it to let the flame from the cap travel to the powder charge in the barrel.

**open sights.** The simplest kind of sights, consisting of a rear bar with either a V-shaped or U-shaped notch cut into it, and a front blade or bead. The shooter aims by aligning the notch in the rear sight with the front blade or bead and superimposing that alignment on the target.

**optical sights.** Telescopic sights, consisting of a tube containing magnifying lenses and an aiming reticle. *See* reticles.

**pan.** On matchlock, wheel lock, and flintlock guns, a small, shallow container for priming powder.

**patch.** A piece of material, usually cotton, fitted around a round ball in a muzzleloading gun to provide a gas seal and to impart spin to the ball.

**peep sights.** *See* aperture sights.

**pellet.** Ammunition fired by rifled-barreled CO<sub>2</sub>, pneumatic (pump-up), and spring-operated air guns.

**percussion cap.** A small metal cup containing a priming mixture (detonating powder), placed open-end-down over a nipple that has a vent hole leading into the main powder charge in the barrel of a percussion rifle. When struck by the hammer, the cap sends a small jet of flame into the powder charge, igniting it.

**percussion rifle.** A muzzleloading rifle using a percussion cap and hammer to ignite the powder charge.

**possibles bag.** A pouch carried by a muzzleloader shooter, for packing necessary gear.

**powder charge.** A measured amount of a chemical compound that, when ignited by the primer, generates gases that expand rapidly and produce high pressure, providing the force needed to propel a projectile. In modern cartridges, the powder charge is contained within the case. In muzzleloading rifles, the powder charge is loaded into the barrel through the muzzle. The black powder used in muzzleloaders is quite different from the powder used in modern cartridges.

**powder horn.** A container for holding black powder. Modern powder flasks are usually made of metal, with a spout on one end and a lever at the side that opens the flask to pour out a measured amount of powder.

**powder measure.** A device for measuring and dispensing precise quantities of powder.

**primer.** In cartridge arms, an impact-sensitive chemical mixture that ignites when hit by the firing pin, igniting the powder charge. Also, in centerfire ammunition, the metal cup or pocket that contains the primer.

**priming charge.** The fine-grained powder that is used in the pan of a flintlock and that, when set off, ignites the main charge of powder.

**priming pan.** *See* pan.

**projectile.** Any solid material propelled through the gun barrel by pressure—a bullet, ball, BB, pellet, etc.

**prone position.** A shooting position in which the shooter lies facing the target, body angled slightly, both elbows and almost all of the body in contact with the ground.

**pump action.** A term applied to repeating firearms activated by a sliding action that is operated by moving a handgrip below the barrel backwards and forwards.

**pyrite.** A common mineral that has a pale brass-yellow color and a metallic luster.

**Pyrodex®.** A modified black powder or black-powder substitute that burns without the heavy fouling of regular black powder.

**ramrod.** A rod used in loading and cleaning muzzleloading guns.

**range safety officer.** The person giving standard range commands and monitoring all shooters at a supervised shooting range.

**receiver.** The frame for the action parts of a gun, and the part of the firearm around which the rest of the arm is built. A rifle's stock is attached to the receiver; the barrel is screwed or locked into the receiver; and the receiver also accepts the bolt, magazine, trigger mechanism, etc.

**recoil.** The rearward movement of the gun in reaction to the forward movement of the projectile and powder gas emerging from the muzzle; the kick-back of a gun upon firing.

**repeater.** *See* semiautomatic.

**reticle.** The aiming device in a telescopic sight, arranged within the lens system of the scope to focus perfectly on the target. Common patterns include crosshairs (in various thicknesses); crosshair and dot; dot; crosshair and post; and post (flat-topped or pointed).

**rifling.** The lands (raised surfaces) and grooves in a barrel that make the bullet spin, imparting greater accuracy.

**rimfire.** Cartridges with the primer contained in a fold (rim) at the base of the case, which when struck by the hammer ignites the powder charge.

**round.** Another name for a cartridge.

**round ball.** A round projectile, usually of lead and usually fired with a cloth patch, fired from a muzzleloading rifle.

**safety.** A device that prevents a firearm from being accidentally fired, normally by blocking the trigger or the hammer action or by locking the bolt or lever.

**scoring gauge.** A device used for indicating the location of bullet holes in a paper target or for measuring the distance between holes.

**scoring ring.** A black or white paper-target ring used to separate scoring areas of different values.

**semiautomatic.** A firearm that fires the cartridge in the chamber, ejects the fired casing, and chambers a fresh round from the magazine with each pull of the trigger. *See also* autoloader.

**short-starter.** The short peg of a ball-starter, used to seat a patched ball or lubed bullet just below the muzzle of a muzzleloading gun.

**sight alignment.** The alignment of eye, rear sight, and front sight.

**sight picture.** The visual image that the shooter sees as he lines the sights on the target; the relationship between the eye, the aligned sights or scope, and the target.

**sighting-in.** Adjusting the sights on a rifle so that the projectile strikes the target where intended; also known as zeroing-in.

**sights.** The metallic or optical devices attached to rifles that enable them to be aimed. *See* aperture sights; open sights; optical sights.

**single-set trigger.** A single trigger that combines the functions of both triggers of a double-set mechanism. After it is set (usually by being pushed forward), a very light pull will release the trigger. *See* double-set trigger.

**sitting position.** A shooting position in which the shooter sits, legs extended from the body with ankles crossed, resting elbows inside knees.

**six-o'clock hold.** In target shooting, aligning the front sight directly below the bull's-eye, as if the bull's-eye were resting atop the front sight.

**slide action.** *See* pump action.

**sprue.** The excess metal that hardens in the opening of a ball-casting mold through which the molten metal is poured into the mold. Also, the slight projection on the ball that is left from the hole in the mold.

**squib round.** A round that fires but does not produce enough gas pressure to force the bullet out of the barrel.

**standing position.** A shooting position in which the shooter stands with head erect, feet shoulder-width apart, knees straight, and body weight distributed equally on both feet.

**starter.** *See* ball-starter; short-starter.

**starting load.** Powder charge in a muzzleloading gun, generally in a measure of one grain of powder per caliber. For instance, a .45 caliber rifle would take 45 grains of powder as a starting load.

**stock.** The part of a rifle that the shooter grasps, usually made of wood, and consisting of the butt, comb, grip, and fore-end.

**tang.** The part of a firearm's receiver that extends to the rear and is used to attach the action to the stock.

**10-ring.** The innermost ring of the black section (the bull's-eye) of the target.

**thimbles.** Short metal tubes used to secure the ramrod under the barrel of a muzzleloading gun.

**trigger.** The lever that activates a firearm when moved, usually pulled by one finger.

**trigger control.** Deliberate squeezing of the trigger straight to the rear without disturbing the sight picture.

**trigger guard.** A protective shield around the trigger that guards against accidental release of the trigger.

**trigger pull.** The amount of pressure needed to fully release a trigger to fire a gun.

**windage.** Horizontal adjustment of the sights on a firearm to send the projectile to the right or the left on the target.

**work-rod.** A rod heavier than a ramrod, used for special tasks such as pulling a ball from the barrel of a muzzleloading gun.

**wrist.** The part of the stock between the butt and the fore-end that is gripped by the trigger-hand.

**zero.** The point at which a rifle's sights are adjusted to the proper point of impact. *See* sighting-in.

**zeroing.** The mechanical movement of the sights to center the shot group in the center of the target. *See* sighting-in.



# Resources

## Scouting Literature

*Environmental Science, Fish and Wildlife Management*, and *Shotgun Shooting* merit badge pamphlets; *Guide to Safe Scouting; Health and Safety Guide*

Visit the Boy Scouts of America's official retail Web site at <http://www.scoutstuff.org> for a complete listing of all merit badge pamphlets and other helpful Scouting materials and supplies.

## Rifles and Rifle Shooting

Anderson, Gary L. *NRA Junior Rifle Shooting*. National Rifle Association of America, Washington, D.C., 1983.

Bassham, Lanny R. *With Winning in Mind*. Bookpartners Inc., 1996.

Crossman, Jim. *Olympic Shooting*. National Rifle Association of America, Washington, D.C., 1978.

Parish, David. *Successful Rifle Shooting*. Crowood Press, 1997.

Sheets, H. Wayne. *The Basics of Rifle Shooting*. National Rifle Association of America, Washington, D.C., 1987.

Trefethen, James B. *Americans and Their Guns*. Stackpole Books, Harrisburg, PA, 1967.

Yuryev, A. A. *Competitive Shooting*. National Rifle Association of America, Washington, D.C., 1985.

## Muzzleloaders

Bridges, Toby. *Muzzleloading*. Creative Publishing, 1997.

*The Muzzleloading Rifle Handbook*. National Rifle Association of America, Washington, D.C., 1985.

## Organizations and Web Sites

### Alco Target Company

Toll-free telephone: 888-258-4814  
Web site: <http://www.alcotarget.com>

### American Target Company

Telephone: 303-733-0433

### Central Target Company

Telephone: 502-895-3390

### Michaels of Oregon

Toll-free telephone: 800-962-5757  
Web site: <http://www.hoppes.com> or  
<http://www.michaelsoforegon.com>

**National Target Company**

Toll-free telephone: 800-827-7060

Web site:

<http://www.nationaltarget.com>

**Target Barn Inc.**

Telephone: 419-829-2242

**The Target Shop**

Toll-free telephone: 800-746-6812

**U.S. Target Company**

Toll-free telephone: 800-746-6836

Web site:

<http://www.ustargetonline.com>

## Acknowledgments

For their many contributions to this new edition of the *Rifle Shooting* merit badge pamphlet, the Boy Scouts of America thanks Charles Mitchell, Howard Q. Moody, and Rudy Dufour of the National Rifle Association; and J. Franklin Sturges Jr., National Camping School shooting sports director, Denver Area Council shooting sports coordinator, and NRA training counselor. Their assistance was indispensable with producing this new edition. Thanks also to David Prizio Jr., NCS shooting sports director, Western Region, for reviewing the manuscript.

We appreciate Troop 660, Falls Church, Va., and Troop 1830, Landover, Md., of the BSA's National Capital Area Council, Bethesda, Md., for their assistance with the photographs used in this book.

We appreciate the Quicklist Consulting Committee of the Association for Library Service to Children, a division of the American Library Association, for its assistance with updating the resources section of this merit badge pamphlet.

## Photo and Illustration Credits

All photos and illustrations in this pamphlet are the property of or are protected by the Boy Scouts of America. All illustrations were created by John McDearmon.



## MERIT BADGE LIBRARY

Though intended as an aid to Boy Scouts, Varsity Scouts, and qualified Venturers in meeting merit badge requirements, these pamphlets are of general interest and are made available by many schools and public libraries. The latest revision date of each pamphlet might not correspond with the copyright date shown below, because this list is corrected only once a year, in January. Any number of merit badge pamphlets may be revised throughout the year; others are simply reprinted until a revision becomes necessary.

If a Scout has already started working on a merit badge when a new edition for that pamphlet is introduced, *he may continue to use the same merit badge pamphlet to earn the badge and fulfill the requirements therein.* In other words, the Scout need not start all over again with the new pamphlet and possibly revised requirements.

Merit Badge Pamphlet	Year	Merit Badge Pamphlet	Year	Merit Badge Pamphlet	Year
American Business	2002	Engineering	2008	Photography	2005
American Cultures	2005	Entrepreneurship	2006	Pioneering	2006
American Heritage	2005	Environmental Science	2006	Plant Science	2005
American Labor	2006	Family Life	2005	Plumbing	2004
Animal Science	2006	Farm Mechanics	2008	Pottery	2008
Archaeology	2006	Fingerprinting	2003	Public Health	2005
Archery	2004	Fire Safety	2004	Public Speaking	2002
Architecture	2008	First Aid	2007	Pulp and Paper	2006
Art	2006	Fish and Wildlife		Radio	2008
Astronomy	2004	Management	2004	Railroading	2003
Athletics	2006	Fishing	2009	Reading	2003
Automotive Maintenance	2008	Fly-Fishing	2009	Reptile and	
Aviation	2006	Forestry	2005	Amphibian Study	2005
Backpacking	2007	Gardening	2002	Rifle Shooting	2001
Basketry	2003	Genealogy	2005	Rowing	2006
Bird Study	2005	Geology	2005	Safety	2006
Bugling (see Music)		Golf	2002	Salesmanship	2003
Camping	2005	Graphic Arts	2006	Scholarship	2004
Canoeing	2004	Hiking	2007	Scuba Diving	2009
Chemistry	2004	Home Repairs	2009	Sculpture	2007
Cinematography	2008	Horsemanship	2003	Shotgun Shooting	2005
Citizenship in the		Indian Lore	2008	Skating	2005
Community	2005	Insect Study	2008	Small-Boat Sailing	2004
Citizenship in the Nation	2005	Journalism	2006	Snow Sports	2007
Citizenship in the World	2005	Landscape Architecture	2008	Soil and Water	
Climbing	2006	Law	2003	Conservation	2004
Coin Collecting	2008	Leatherwork	2002	Space Exploration	2004
Collections	2008	Lifesaving	2008	Sports	2006
Communication	2009	Mammal Study	2003	Stamp Collecting	2007
Composite Materials	2006	Medicine	2009	Surveying	2004
Computers	2009	Metalwork	2007	Swimming	2008
Cooking	2007	Model Design and Building	2003	Textile	2003
Crime Prevention	2005	Motorboating	2008	Theater	2005
Cycling	2003	Music and Bugling	2003	Traffic Safety	2006
Dentistry	2006	Nature	2003	Truck Transportation	2005
Disabilities Awareness	2005	Nuclear Science	2004	Veterinary Medicine	2005
Dog Care	2003	Oceanography	2009	Water Sports	2007
Drafting	2008	Orienteering	2003	Weather	2006
Electricity	2004	Painting	2008	Whitewater	2005
Electronics	2004	Personal Fitness	2006	Wilderness Survival	2007
Emergency Preparedness	2008	Personal Management	2003	Wood Carving	2006
Energy	2005	Pets	2003	Woodwork	2003

## BOY SCOUTS OF AMERICA • SUPPLY GROUP

### NATIONAL DISTRIBUTION CENTER

2109 Westinghouse Boulevard  
P.O. Box 7143  
Charlotte, NC 28241-7143

[www.scoutstuff.org](http://www.scoutstuff.org)

### DIRECT MAIL CENTER

P.O. Box 909  
Pineville, NC 28134-0909  
For fast credit card orders—

VISA, MasterCard, American Express—  
call BSA operators toll-free  
1-800-323-0732



PHILMONT SCOUT RANCH



NORTHERN TIER



EAGLE SCOUT



FLORIDA SEA BASE

ON THE ROAD TO HIGH ADVENTURE

THE SUPPLY GROUP IS READY TO BE A PARTNER ON YOUR TRAIL TO EAGLE THROUGH HIGH ADVENTURE. THE ADVENTURE IS YOURS, AND WE ARE READY WITH THE GEAR YOU WILL NEED. YOU CAN DEPEND ON THE LATEST IN LIGHTWEIGHT, DURABLE, QUALITY GEAR THAT WILL MEET AND SURPASS YOUR TOUGHEST REQUIREMENTS.



WWW.SCOUTSTUFF.ORG

SKU 35942



7 30176 35942 7  
35942 2010 Printing